

2022

# CATALOGO PRODOTTI

## PRODUCT CATALOGUE

ACCESSORI PROFESSIONALI  
PER AUTOLAVAGGI SELF SERVICE E NON

*PROFESSIONAL ACCESSORIES  
FOR SELF SERVICE AND NON SELF SERVICE CAR WASH*

A.D. Produzione S.r.l.

IT MAKES THE DIFFERENCE

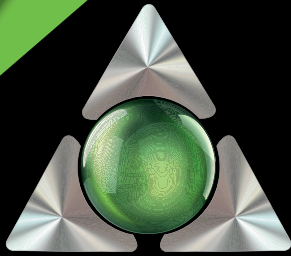

# A.D. Produzione s.r.l.

dal 1997  
sinonimo di

since 1997  
synonymous with



Esperienza  
Experience



Tecnologia  
Technology



Rispetto  
Respect

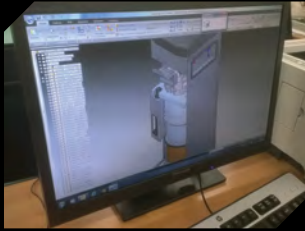

PROGETTAZIONE  
ENGINEER DESIGN



CARPENTERIA  
STEEL CARPENTRY



MONTAGGIO  
ASSEMBLY



ACCESSORI  
ACCESSORIES



LAVATAPPETI  
CAR-MAT WASHERS



EROGATORI  
PRODUCT DISPENSER



DISTRIBITORI  
DISPENSER



ASPIRAPOLVERI  
VACUUM CLEANERS



LAVAINTERNI  
INTERIORS CLEANER



QUADRI ELETTRICI  
ELECTRIC PANELS



REPARTO GRAFICO  
GRAPHIC DEPARTMENT

LINEE PRODUTTIVE PRODUCTION LINES



[www.adproduzione.com](http://www.adproduzione.com)

# CERTIFICAZIONI

## Certifications



La direttiva 86/217 CEE 2009/34/CE stabilisce che il gonfia gomme non è una macchina, ma uno strumento metrico, pertanto è soggetto a omologazione con verifica prima (una volta omologato non è sottoposto ad altre verifiche).

CERTIFICAZIONE ISO 9001:2015  
ISO 9001:2015 CERTIFICATION

Essendo A.D. Produzione anche costruttore metrico, produce i propri gonfia gomme omologati, come richiesto dalla direttiva 86/217 CEE 2009/34/CE.

Directive 86/217 CEE 2009/34/CE establishes that the tyre inflator is not a machine, but a metric instrument, therefore it is only subjected to a prior homologation (once homologated it no longer undergoes additional verifications).

A.D. Produzione produces its own inflator for tyres as required by the regulations.

► DICHIARAZIONE DI CONFORMITÀ CE  
DECLARATION OF CONFORMITY

► MANUALE DI ISTRUZIONI  
INSTRUCTION MANUAL

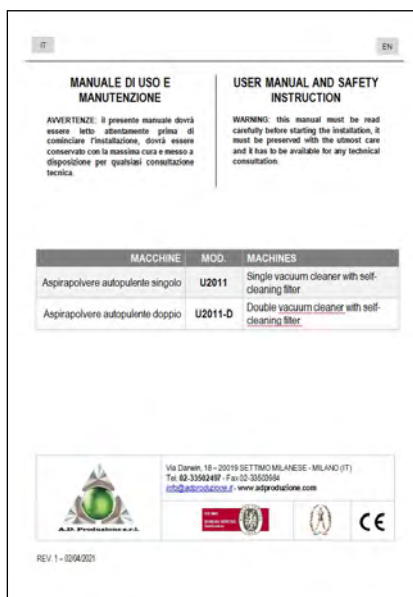
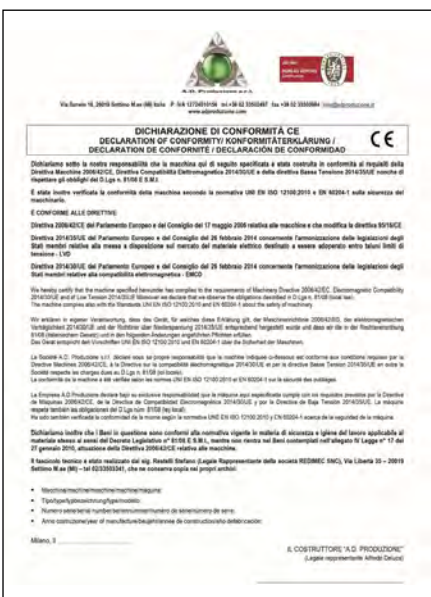

Tutte le macchine e gli accessori AD Produzione sono realizzate con Acciaio INOX AISI 304.

All the AD Produzione equipments and accessories are made of *Stainless Steel AISI 304*.

|  |    |
|--|----|
| PERSONALIZZAZIONE GRAFICA<br>GRAPHIC CUSTOMIZATION | 5  |
| ASPIRAPOLVERI<br>VACUUM CLEANERS                   | 6  |
| LAVAINTERNI<br>INTERIORS CLEANER                   | 12 |
| SANIFICANTE CASCHI<br>HYGIENIC MACHINE FOR HELMETS | 14 |
| LAVATAPPETI<br>CAR-MAT WASHERS                     | 15 |
| DISTRIBUTORI<br>DISPENSER                          | 16 |
| EROGATORI PRODOTTO<br>PRODUCT DISPENSER            | 19 |
| GONFIA GOMME<br>TYRE INFLATOR                      | 26 |
| MACCHINE COMBinate<br>COMBINED MACHINES            | 29 |
| SPREMIPELLE<br>LEATHER SQUEEZER                    | 31 |
| NEBULIZZATORI<br>NEBULIZER                         | 32 |
| CESTINI PORTARIFIUTI<br>WASTE BASKET               | 33 |
| ACCESSORI<br>ACCESSORIES                           | 34 |
| OPZIONALI<br>OPTIONALS                             | 36 |
| RICAMBI<br>SPARE PARTS                             | 39 |

## PERSONALIZZAZIONE GRAFICA

Graphic Customization



Dal 2012, grazie al nostro **REPARTO GRAFICO INTERNO**, siamo in grado di **personalizzare** gli adesivi di tutte le macchine.



*Since 2012, thanks to our internal graphic department, we are able to customize the stickers of every machines.*



Il servizio di stampa digitale per gli adesivi delle nostre macchine utilizza PVC adesivo polimerico con finitura bianca lucida e adesivo permanente. La laminazione trasparente è studiata per durare e resistere nel tempo grazie alla finitura antigraffio e anti-UV.

*The digital printing service for the stickers of our machines uses polymeric adhesive PVC with a glossy white finish and permanent adhesive. The transparent lamination is designed to last a long time thanks to the anti-scratch and anti-UV finish.*

# ASPIRAPOLVERI Mod. AD

AD Mod. Vacuum Cleaners



MOD. AD-00SA  
MOD. AD-01SA  
MOD. AD-00SC  
MOD. AD-01SC



MOD. AD-00DA  
MOD. AD-01DA  
MOD. AD-00DC  
MOD. AD-01DC

Opzionali: Cappello Inox,  
Sollevatubo, Kit Allarme  
Optional: Sainless Steel  
Cover, Spring Piper Lifter,  
Anomaly Alarm



Max 2 kit

Macchine con Kit  
Prodotti opzionale  
Machines with  
Product Kit optional



Max 3 kit



| MOD.                             | AD-00SA   | AD-01SA   | AD-00SC   | AD-01SC   | AD-00DA   | AD-01DA   | AD-00DC   | AD-01DC   |
|----------------------------------|---|---|---|---|---|---|---|---|
| <b>CAPPELLO COVER</b>            | In ABS nero<br>Black                              | In ABS nero<br>Black                              | In ABS nero<br>Black                              | In ABS nero<br>Black                              | In ABS nero<br>Black                              | In ABS nero<br>Black                              | In ABS nero<br>Black                              | In ABS nero<br>Black                              |
| <b>VERSIONE VERSION</b>          | Singolo<br>Single                                 | Singolo<br>Single                                 | Singolo<br>Single                                 | Singolo<br>Single                                 | Doppio<br>Double                                  | Doppio<br>Double                                  | Doppio<br>Double                                  | Doppio<br>Double                                  |
| <b>FILTRO FILTER</b>             | Autopulente<br>Self-cleaning                      | Autopulente<br>Self-cleaning                      | Classico<br>Classic                               | Classico<br>Classic                               | Autopulente<br>Self-cleaning                      | Autopulente<br>Self-cleaning                      | Classico<br>Classic                               | Classico<br>Classic                               |
| <b>TENSIONE VOLTAGE</b>          | 400 V   | 400 V   | 400 V   | 400 V   | 400 V   | 400 V   | 400 V   | 400 V   |
| <b>POTENZA POWER</b>             | 2.2 kW  | 3.0 kW  | 2.2 kW  | 3.0 kW  | 2.2 kW x2   | 3.0 kW x2   | 2.2 kW x2   | 3.0 kW x2   |
| <b>PORTATA CAPACITY</b>          | 320 m <sup>3</sup> /h                             | 320 m <sup>3</sup> /h                             | 320 m <sup>3</sup> /h                             | 320 m <sup>3</sup> /h                             | 320 m <sup>3</sup> /h                             | 320 m <sup>3</sup> /h                             | 320 m <sup>3</sup> /h                             | 320 m <sup>3</sup> /h                             |
| <b>GETTONIERA COIN VALIDATOR</b> | Elettronica<br>Electronic                         | Elettronica<br>Electronic                         | Elettronica<br>Electronic                         | Elettronica<br>Electronic                         | Elettronica<br>Electronic                         | Elettronica<br>Electronic                         | Elettronica<br>Electronic                         | Elettronica<br>Electronic                         |
| <b>PORTA DOOR</b>                | Con serratura<br>blindata<br>With armored<br>lock | Con serratura<br>blindata<br>With armored<br>lock | Con serratura<br>blindata<br>With armored<br>lock | Con serratura<br>blindata<br>With armored<br>lock | Con serratura<br>blindata<br>With armored<br>lock | Con Serratura<br>blindata<br>With armored<br>lock | Con serratura<br>blindata<br>With armored<br>lock | Con serratura<br>blindata<br>With armored<br>lock |
| <b>PESO WEIGHT</b>               | 124 kg  | 125 kg  | 94 kg   | 95 kg   | 200 kg  | 201 kg  | 140 kg  | 141 kg  |

# ASPIRAPOLVERI Mod. U2011

U2011 Mod. Vacuum Cleaners



MOD. U2011-S



MOD. U2011-D



## Opzionali più richiesti

Tutti gli opzionali si possono visionare a pag. 36  
All optional can be viewed on page 36



KIT PRODOTTO  
PRODUCT KIT



SOLLEVATUBO A MOLLA  
SPRING PEPPER LIFTER



BRACCIO GIREVOLE  
ROTATING ARM



CAPPELLO INOX  
STAINLESS STEEL COVER

| MOD.                      | U2011-S   | U2011-D   |
|---------------------------|---|---|
| CAPPELLO COVER            | In ABS nero<br>Black  | In ABS nero<br>Black  |
| VERSIONE VERSION          | Singolo<br>Single   | Doppio<br>Double  |
| FILTRO FILTER             | Autopulente<br>Self-cleaning                                      | Autopulente<br>Self-cleaning                                      |
| TENSIONE VOLTAGE          | 400 V   | 400 V   |
| POTENZA POWER             | 2.2 kW  | 2.2 kW x2   |
| PORTATA CAPACITY          | 320 m <sup>3</sup> /h   | 320 m <sup>3</sup> /h   |
| GETTONIERA COIN VALIDATOR | Elettronica<br>Electronic   | Elettronica<br>Electronic   |
| PORTA DOOR                | Unica con serratura semplice<br>Single door with pin tumbler lock | Unica con serratura semplice<br>Single door with pin tumbler lock |
| PESO WEIGHT               | 125 kg  | 180 kg  |

# ASPIRAPOLVERI Mod. ECO

ECO Mod. Vacuum Cleaners



MOD. ECO 400  
MOD. ECO 230



MOD. ECO 400-D  
MOD. ECO 230-D

## Opzionali più richiesti

Tutti gli opzionali si possono visionare a pag. 36  
All optional can be viewed on page 36



KIT PRODOTTO  
PRODUCT KIT



CAPPELLO INOX  
STAINLESS STEEL COVER



SOLLEVATUBO A MOLLA  
SPRING PIPER LIFTER



BRACCIO GIREVOLE  
ROTATING ARM

| MOD.                             | ECO 400  | ECO 230  | ECO 400-D  | ECO 230-D  |
|----------------------------------|--|--|--|--|
| <b>CAPPELLO COVER</b>            | In ABS nero<br><i>Black</i>  | In ABS nero<br><i>Black</i>  | In ABS nero<br><i>Black</i>  | In ABS nero<br><i>Black</i>  |
| <b>VERSIONE VERSION</b>          | Singolo<br><i>Single</i>   | Singolo<br><i>Single</i>   | Doppio<br><i>Double</i>  | Doppio<br><i>Double</i>  |
| <b>FILTRO FILTER</b>             | Classico<br><i>Classic</i>   | Classico<br><i>Classic</i>   | Classico<br><i>Classic</i>   | Classico<br><i>Classic</i>   |
| <b>TENSIONE VOLTAGE</b>          | 400 V  | 230 V monofase<br><i>230 V mono-phase</i>                                | 400 V  | 230 V monofase<br><i>230 V mono-phase</i>                                |
| <b>POTENZA POWER</b>             | 2.2 kW   | 2.0 kW   | 2.2 kW x2  | 2.0 kW x2  |
| <b>PORTATA CAPACITY</b>          | 320 m <sup>3</sup> /h  | 420 m <sup>3</sup> /h  | 320 m <sup>3</sup> /h  | 420 m <sup>3</sup> /h  |
| <b>GETTONIERA COIN VALIDATOR</b> | Meccanica<br><i>Mechanical</i>   | Meccanica<br><i>Mechanical</i>   | Meccanica<br><i>Mechanical</i>   | Meccanica<br><i>Mechanical</i>   |
| <b>PORTA DOOR</b>                | Unica con serratura semplice<br><i>Single door with pin tumbler lock</i> | Unica con serratura semplice<br><i>Single door with pin tumbler lock</i> | Unica con serratura semplice<br><i>Single door with pin tumbler lock</i> | Unica con serratura semplice<br><i>Single door with pin tumbler lock</i> |
| <b>PESO WEIGHT</b>               | 83 kg  | 57 kg  | 150 kg   | 100 kg   |



# ASPIRAPOLVERI Mod. TO e U4P

TO and U4P Mod. Vacuum Cleaners



MOD. TOT  
MOD. TOF  
MOD. TOBT  
MOD. TOBF



MOD. U4P\*



\*Per il programma aria compressa è necessario l'arrivo dell'aria da un compressore esterno. La macchina non include il compressore.

\*Please note: air must be brought to the machine by an external air compressor (not included).



| MOD.                      | TOT  | TOF  | TOBT   | TOBF   | U4P*   |
|---------------------------|--|--|--|--|--|
| CAPPELLO COVER            | /  | /  | /  | /  | In ABS nero Black  |
| PROGRAMMI PROGRAMS        | Possibilità di aggiungere 1 Kit Prodotto a scelta come OPZIONALE<br><i>Possibility to add 1 Product Kit of your choice as OPTIONAL</i>                 | Possibilità di aggiungere 1 Kit Prodotto a scelta come OPZIONALE<br><i>Possibility to add 1 Product Kit of your choice as OPTIONAL</i>                 | Possibilità di aggiungere 1 Kit Prodotto a scelta come OPZIONALE<br><i>Possibility to add 1 Product Kit of your choice as OPTIONAL</i>                 | Possibilità di aggiungere 1 Kit Prodotto a scelta come OPZIONALE<br><i>Possibility to add 1 Product Kit of your choice as OPTIONAL</i>                 | Aspirapolvere - Aria compressa - Profumo - Nero gomme.<br><i>Vacuum cleaners - Compressed air - Perfume - Tyre blacking.</i> |
| FILTRO FILTER             | Autopulente<br><i>Self-cleaning</i>  | Autopulente<br><i>Self-cleaning</i>  | Classico<br><i>Classic</i>   | Classico<br><i>Classic</i>   | Autopulente<br><i>Self-cleaning</i>  |
| TENSIONE VOLTAGE          | 400 V  | 400 V  | 400 V  | 400 V  | 400 V  |
| POTENZA POWER             | 2.2 kW   | 3.0 kW   | 2.2 kW   | 3.0 kW   | 2.2 kW   |
| PORTATA CAPACITY          | 320 m <sup>3</sup> /h  | 320 m <sup>3</sup> /h  | 320 m <sup>3</sup> /h  | 320 m <sup>3</sup> /h  | 320 m <sup>3</sup> /h  |
| GETTONIERA COIN VALIDATOR | Elettronica<br><i>Electronic</i>   | Elettronica<br><i>Electronic</i>   | Elettronica<br><i>Electronic</i>   | Elettronica<br><i>Electronic</i>   | Elettronica<br><i>Electronic</i>   |
| PORTA DOOR                | Con serratura blindata (in alto) e con serratura semplice (in basso).<br><i>Armored lock (on upper door) and pin tumbler lock (on the lower door).</i> | Con serratura blindata (in alto) e con serratura semplice (in basso).<br><i>Armored lock (on upper door) and pin tumbler lock (on the lower door).</i> | Con serratura blindata (in alto) e con serratura semplice (in basso).<br><i>Armored lock (on upper door) and pin tumbler lock (on the lower door).</i> | Con serratura blindata (in alto) e con serratura semplice (in basso).<br><i>Armored lock (on upper door) and pin tumbler lock (on the lower door).</i> | Unica con serratura semplice<br><i>Single door with pin tumbler lock</i>   |
| PESO WEIGHT               | 127 kg   | 128 kg   | 97 kg  | 98 kg  | 130 kg   |

## ASPIRAPOLVERI NO-SELF e CARRELLATI

No-self and wheeled Vacuum Cleaners



⚠ Il sollevatubo a molla non è incluso nella macchina, è un opzionale.  
The spring pipe lifter is not included in the machine; it's an optional.



| MOD.                         | AF3   | E1  | S1  |
|------------------------------|---|---|---|
| FILTRO<br>FILTER             | Autopulente<br>Self-cleaning  | Classico<br>Classic   | Autopulente<br>Self-cleaning  |
| TENSIONE<br>VOLTAGE          | 400 V   | 400 V   | 400 V   |
| POTENZA<br>POWER             | 3.0 kW  | 2.2 kW  | 2.2 kW  |
| PORTATA<br>CAPACITY          | 320 m <sup>3</sup> /h   | /   | /   |
| GETTONIERA<br>COIN VALIDATOR | Senza<br>Without  | Senza<br>Without  | Senza<br>Without  |
| FUNZIONAMENTO<br>OPERATION   | Manuale, con interruttore<br>Manual functioning (on/<br>off button) | Manuale, con interruttore<br>Manual functioning (on/<br>off button) | Manuale, con interruttore<br>Manual functioning (on/<br>off button) |
| PESO<br>WEIGHT               | 80 kg   | 70 kg   | 70 kg   |

Opzionali più richiesti  
per mod. AF3

Tutti gli opzionali si possono  
visionare a pag. 36  
All options can be viewed on  
page 36



KIT PRODOTTO  
PRODUCT KIT



SOLLEVATUBO A MOLLA  
SPRING PIPER LIFTER

## ASPIRAPOLVERI CARRELLATI

Wheeled Vacuum Cleaners



Aspirapolvere con turbine di differenti motorizzazioni, monostadio, ad uno o due motori tristadio con avviamento indipendente per uso continuativo o ibridi a batteria gel per utilizzo outdoor. Struttura in acciaio inox 430 con possibilità di pulizia dei filtri tramite scuotimento manuale, con doppia filtrazione o cartuccia. Fusti facilmente sganciabili con possibilità di utilizzo sacchi di raccolta. Silenziatore, ruote robuste con freno e svuotamento facilitato del fusto di raccolta sganciabile ed amovibile.

Per l'aspirazione di residui tossici è necessario l'utilizzo di una macchina che garantisca l'abbattimento delle particelle nocive. Questi aspiratori sono certificati per tale utilizzo.

CLASSE H (rischio elevato) per separare tutte le polveri con tutti i valori limite di esposizione in funzione del volume occupato, incluse le polveri cancerogene e patogene.

Vacuum cleaner equipped with turbines with different motors, single-stage, one or two three-stage motors with independent start, suitable for continuous application, or hybrid with gel batteries for outdoor applications. Structure in stainless steel 430 with possibility to clean the filters through manual waggle, with double filtration or cartridge. They are easy to unhook with possibility to install collection bags. Muffler, solid wheels with brake and easy emptying of the collection tank.

For the extraction of toxic residues it is necessary to use a machine that guarantees the elimination of harmful particles. These vacuum cleaners are approved for such use.

CLASS H (high risk) separates all the dust with all exposure limit values according to the volume occupied, including carcinogenic and pathogenic dust.

| MOD.                                | PLANET 130                    | 515                           | PANDA 429 MARK                |
|-------------------------------------|-------------------------------|-------------------------------|-------------------------------|
| FUNZIONAMENTO<br>OPERATION          | Manuale<br>Manual functioning | Manuale<br>Manual functioning | Manuale<br>Manual functioning |
| TENSIONE<br>VOLTAGE                 | 380 - 400 V                   | 230 V                         | 230 V                         |
| POTENZA<br>POWER                    | 3.0 kW                        | 1.2 kW                        | 2.4 kW                        |
| DEPRESSIONE<br>DEPRESSION           | 2750 mm H <sub>2</sub> O      | 2470 mm H <sub>2</sub> O      | 2470 mm H <sub>2</sub> O      |
| PORTATA ARIA<br>AIR FLOW            | 350 m <sup>3</sup> /h         | 210 m <sup>3</sup> /h         | 420 m <sup>3</sup> /h         |
| FUSTO<br>TANK                       | 60 L                          | 32 L                          | 62 L                          |
| SUPERFICIE FILTRO<br>FILTER SURFACE | 7000 cm <sup>2</sup>          | /                             | /                             |
| PESO<br>WEIGHT                      | 70 kg                         | 40 kg                         | 40 kg                         |

# LAVAINTERNI Mod. LI

LI Mod. Interiors Cleaners



- Necessita di uno scarico dei liquidi.
- Non adatta per lavaggio dei sedili in pelle.
- Dirty liquids must be drained to plughole.
- Don't use on leather seats.



- Non adatta per lavaggio dei sedili in pelle.
- Don't use on leather seats.



- Necessita di uno scarico dei liquidi.
- Non adatta per lavaggio dei sedili in pelle.
- Dirty liquids must be drained to plughole.
- Don't use on leather seats.



## Opzionali più richiesti

Tutti gli opzionali si possono visionare a pag. 36  
All optionals can be viewed on page 36



CAPPELLO INOX  
STAINLESS STEEL COVER



SOLLEVATUBO A MOLLA  
SPRING PIPER LIFTER



EROGATORE DI SPAZZOLE PERSONALI  
DISPENSER PERSONAL BRUSH

| MOD.                      | LI  | LI-S  | LI-SE   |
|---------------------------|---|---|---|
| CAPPELLO COVER            | /   | In ABS nero<br>Black                              | In ABS nero<br>Black  |
| VERSIONE VERSION          | Lavainterni ad iniezione ed estrazione<br>Injection and extraction interiors cleaner  | Lavainterni con schiuma<br>Foam interiors cleaner | Lavainterni 4 programmi<br>4 programs interiors cleaner                                     |
| PROGRAMMI PROGRAMS        | /   | /   | Schiuma, Igenizzazione,<br>Iniezione, estrazione.<br>Foam, Hygienic, Injection, Extraction. |
| TENSIONE VOLTAGE          | 400 V   | 400 V   | 400 V   |
| POTENZA POWER             | 2.2 kW  | 2.2 kW  | 2.2 kW  |
| GETTONIERA COIN VALIDATOR | Elettronica<br>Electronic   | Elettronica<br>Electronic                         | Elettronica<br>Electronic   |
| PORTA DOOR                | Con serratura blindata (in alto) e con serratura semplice (in basso).<br>Armored lock (on upper door) and pin tumbler lock (on the lower door). | Con serratura blindata<br>With armored lock       | Con serratura blindata<br>With armored lock   |
| PESO WEIGHT               | 113 kg  | 103 kg  | 150 kg  |

## LAVAINTERNI CARRELLATI

Wheeled Interiors Cleaners

MOD. GENIUS



MOD. JOB

Sono macchine polivalenti che permettono di lavare facilmente e rapidamente con il sistema di iniezione-estrazione ogni tipo di superficie: moquette, tappeti, tendaggi, interni di auto, poltrone, pavimenti, pareti ecc. Dotati di due potenti motori aspiranti permettono di asciugare più velocemente la superficie lavata. Sono le macchine ideali per autolavaggi e imprese di pulizia. Tutti gli apparecchi possono essere utilizzati anche come aspirapolvere e aspira liquidi.

Wheeled interiors cleaners are multipurpose machines that allow you to wash easily and quickly with the injection-extraction system every type of surface: mouquettes, carpets, curtains, car interiors, chairs, floors, walls etc. They are equipped with two powerful engines which allow to dry faster the washed surface. They are the ideal machines for car washes and cleaning companies. All devices can also be used as vacuum cleaner and fluids extractors.

| MOD.                                  | GENIUS                   | JOB         |
|---------------------------------------|--------------------------|-------------|
| TENSIONE<br>VOLTAGE                   | 220 - 240 V              | 220 - 240 V |
| POTENZA<br>POWER                      | 2.4 kW                   | 1.2 kW      |
| POTENZA POMPA<br>PUMP POWER           | 48 kW                    | 48 kW       |
| PORTATA POMPA<br>PUMP FLOW            | 0.8 L/min                | 0.8 L/min   |
| PRESSIONE POMPA<br>PUMP PRESSURE      | 2 bar                    | 2 bar       |
| DEPRESSIONE ACQUA<br>WATER DEPRESSION | 2470 mm H <sub>2</sub> O | /           |
| PORTATA ARIA<br>AIR FLOW              | 420 m <sup>3</sup> /h    | /           |
| FUSTO<br>TANK                         | 60 L                     | 27 L        |
| FUSTO DETERGENTE<br>DETERGENT DRUM    | 25 L                     | 6.2 L       |
| PESO<br>WEIGHT                        | 30 kg                    | 15 kg       |

# SANIFICANTE CASCHI

Hygienic Machine for Helmets



Studiata e progettata, in collaborazione con *Allegrini Spa*, per sanificare caschi di qualsiasi tipo.

*It was designed in collaboration with Allegrini Spa, and it's perfect to sanitize any kind of helmets.*

#### STARTING KIT:

20 kg di prodotto chimico.  
20 kg of chemical product.



KIT BARRE DI SICUREZZA  
SAFETY BARS KIT

#### Opzionali più richiesti

Tutti gli opzionali si possono visionare a pag. 36  
All optionals can be viewed on page 36

Igienizza e sanifica in 3 minuti e mezzo.  
Lascia il casco perfettamente asciutto e subito utilizzabile.

*it sanitize the helmet in 3,5 minutes. It leaves the helmet dry and ready for use immediately*



| MOD.                         | IC                        |
|------------------------------|---------------------------|
| CAPPELLO<br>COVER            | Inox                      |
| TENSIONE<br>VOLTAGE          | 230 V                     |
| POTENZA<br>POWER             | 0.5 kW                    |
| GETTONIERA<br>COIN VALIDATOR | Elettronica<br>Electronic |
| PESO<br>WEIGHT               | 50 kg                     |

# LAVATAPPETI MOD. LT

## LT Mod. Car-Mats Washer

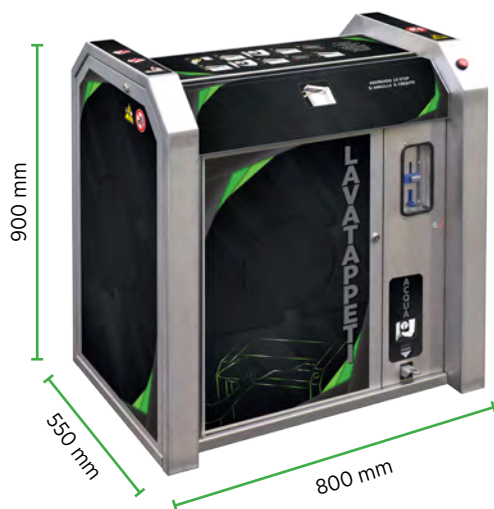

MOD. LT 400  
MOD. LT 230

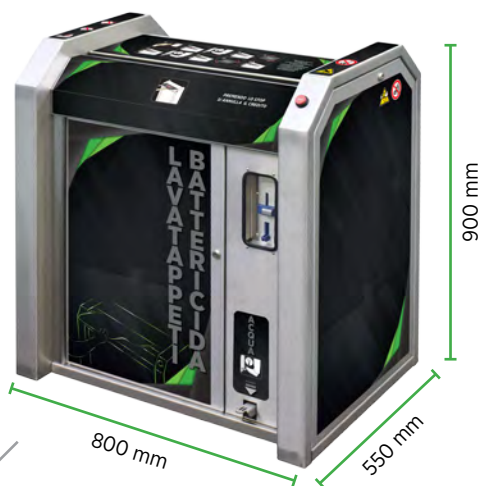

MOD. LT 400-B  
MOD. LT 230-B

MOD. LT 400-ECO  
MOD. LT 230-ECO

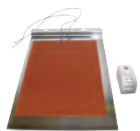
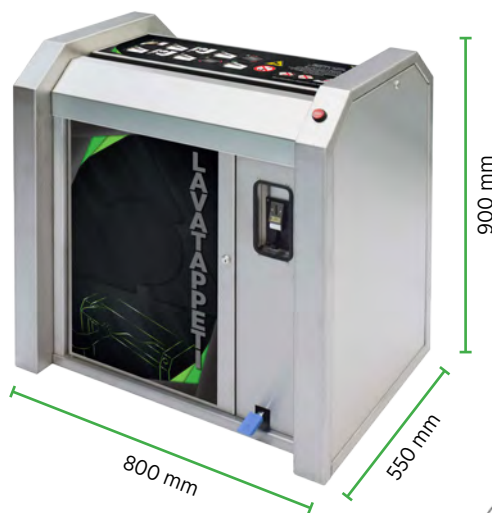

**KIT ANTIGELO CON TERMOSTATO E TERMORESISTENZA**  
ANTIFREEZE KIT WITH THERMISTOR AND THERMOSTAT

### Opzionali più richiesti

Tutti gli opzionali si possono visionare a pag. 36  
*All optionals can be viewed on page 36*



**APPOGGIA TAPPETO SUPERIORE**  
SUPERIOR MAT-FRAME



**APPOGGIA TAPPETO LATERALE**  
LATERAL MAT-FRAME



| MOD.   | LT 400   | LT 230   | LT 400-B   | LT 230-B   | LT 400-ECO                                       | LT 230-ECO                                       |
|--|--|--|--|--|--|--|
| <b>TENSIONE</b><br><i>VOLTAGE</i>                    | 400 V Trifase 3P+n<br>400 V Three-phase 3P+n     | 230 V Monofase<br>230 V Mono-phase               | 400 V Trifase 3P+n<br>400 V Three-phase 3P+n     | 230 V Monofase<br>230 V Mono-phase               | 400 V Trifase 3P+n<br>400 V Three-phase 3P+n     | 230 V Monofase<br>230 V Mono-phase               |
| <b>POTENZA</b><br><i>POWER</i>                       | 1.0 kW   | 1.0 kW   | 1.0 kW   | 1.0 kW   | 1.0 kW   | 1.0 kW   |
| <b>KIT BATTERICIDA</b><br><i>BACTERICIDE KIT</i>     | No   | No   | Di serie<br>Standard                             | Di serie<br>Standard                             | No   | No   |
| <b>SISTEMA ANTIGELO</b><br><i>ANTIFREEZER SYSTEM</i> | Di serie<br>Standard                             | Di serie<br>Standard                             | Di serie<br>Standard                             | Di serie<br>Standard                             | No   | No   |
| <b>GETTONIERA</b><br><i>COIN VALIDATOR</i>           | Elettronica<br>Electronic                        | Elettronica<br>Electronic                        | Elettronica<br>Electronic                        | Elettronica<br>Electronic                        | Meccanica<br>Mechanical                          | Meccanica<br>Mechanical                          |
| <b>PEDALE</b><br><i>PEDAL</i>                        | Elettrico<br>Electronic                          | Elettrico<br>Electronic                          | Elettrico<br>Electronic                          | Elettrico<br>Electronic                          | Meccanico a rubinetto<br>Mechanical with tap     | Meccanico a rubinetto<br>Mechanical with tap     |
| <b>PORTE</b><br><i>DOORS</i>                         | Con serrature semplici<br>With pin tumbler locks | Con serrature semplici<br>With pin tumbler locks | Con serrature semplici<br>With pin tumbler locks | Con serrature semplici<br>With pin tumbler locks | Con serrature semplici<br>With pin tumbler locks | Con serrature semplici<br>With pin tumbler locks |
| <b>PESO</b><br><i>WEIGHT</i>                         | 72 kg  | 72 kg  | 72 kg  | 72 kg  | 72 kg  | 72 kg  |

## DISTRIBUTORI DI CARTA Mod. DC

DC Mod. Tear-off Paper Dispensers



Studiati per erogare, da bobina, carta usa e getta pre-tagliata.

- Larghezza max bobina di carta: 245 mm
- Diametro max bobina di carta: 250 mm
- Peso max bobina di carta: 2,5 Kg
- 800 strappi

These machines have been designed to supply disposable tear-off paper.

- Paper coil max width: 245 mm
- Paper coil max diameter: 250 mm
- Paper coil max weight: 2,5 Kg
- 800 rips



| MOD.                         | DCXN   | DC   |
|------------------------------|--|--|
| CAPPELLO<br>COVER            | In ABS nero<br>Black                             | In ABS nero<br>Black                             |
| VERSIONE<br>VERSION          | Fissaggio a muro<br>Wall setting                 | Fissaggio a pavimento<br>Floor setting           |
| TENSIONE<br>VOLTAGE          | 230 V  | 230 V  |
| POTENZA<br>POWER             | 200 W  | 200 W  |
| GETTONIERA<br>COIN VALIDATOR | Elettronica<br>Electronic                        | Elettronica<br>Electronic                        |
| PORTE<br>DOORS               | Con serrature semplici<br>With pin tumbler locks | Con serrature semplici<br>With pin tumbler locks |
| PESO<br>WEIGHT               | 24 kg  | 45 kg  |

### Opzionali più richiesti

Tutti gli opzionali si possono visionare a pag. 36  
All optional can be viewed on page 36



CAPPELLO INOX  
STAINLESS STEEL COVER



## DISTRIBUTORI DI PANNO Mod. DP

DP Mod. Tear-off Towels Dispensers



Studiata per erogare, da bobina, pezzi di **pele** sintetica pre-tagliata.

- Larghezza max bobina di pelle: 320 mm
- Diametro max bobina di pelle: 360 mm
- Peso max bobina di pelle: 5,8 Kg
- 250 strappi

*This machine has been designed to supply disposable tear-off **leather**.*

- *Leather coil max width: 320 mm*
- *Leather coil max diameter: 360 mm*
- *Leather coil max weight: 5,8 Kg*
- *250 rips*

Studiato per erogare, da bobina, pezzi di **panno carta** pre-tagliata.

- Larghezza max bobina di panno carta: 240 mm
- Diametro max bobina di panno carta: 355 mm
- Peso max bobina di panno carta: 5,5 Kg
- 800 strappi

*This machine has been designed to supply disposable tear-off **paper towel**.*

- *Towel coil max width: 240 mm*
- *Towel coil max diameter: 355 mm*
- *Towel coil max weight: 5,5 Kg*
- *800 rips*



CAPPELLO INOX  
STAINLESS STEEL COVER

### Opzionali più richiesti

Tutti gli opzionali si possono visionare a pag. 36

*All optional can be viewed on page 36*

| MOD.                      | DP  | DPC   |
|---------------------------|---|---|
| CAPPELLO COVER            | Inox  | In ABS nero Black                             |
| VERSIONE VERSION          | Fissaggio a pavimento Floor setting           | Fissaggio a pavimento Floor setting           |
| TENSIONE VOLTAGE          | 230 V   | 230 V   |
| POTENZA POWER             | 200 W   | 200 W   |
| GETTONIERA COIN VALIDATOR | Elettronica Electronic                        | Elettronica Electronic                        |
| PORTE DOORS               | Con serrature semplici With pin tumbler locks | Con serrature semplici With pin tumbler locks |
| PESO WEIGHT               | 67 kg   | 45 kg   |

# DISTRIBUTORI DI ARTICOLI DIVERSIFICATI

Various Items Dispensers



MOD. PANNOMATIC-N

**STARTING KIT:**

- 1 Bobina
- 3 Tanciche prodotto (Vetri, Cruscotto e Fascioni, Igienizzante).
- 1 Towel coil
- 3 Product tanks (Window, Fascias & Dashboards, Sanitizing).



MOD. SV-96

**Distributore di panni umidi PANNOMATIC-N.**

Studiata per erogare panni umidificati di prodotto (già pronti all'uso) e panno asciutto.

La macchina è dotata di un sistema di riscaldamento per le basse temperature.

Larghezza max bobina di carta pannomatic: 240 mm  
 Diametro max bobina di carta pannomatic: 355 mm  
 Peso max bobina di carta pannomatic: 5,5 Kg  
 800 strappi

**Cleaners towel dispenser PANNOMATIC-N.**

This machine has been designed to supply soaked cloth, ready-to-use and dry clothes.

Pannomatic is furnished with heating system for low temperatures.

Pannomatic towel coil max width: 240 mm  
 Pannomatic towel coil max diameter: 355 mm  
 Pannomatic towel coil max weight: 5,5 Kg  
 800 rips

**Distributore di pacchetti SELF-VENDING.**

Studiata per erogare diversi articoli che possono essere preconfezionati (involucro rigido o morbido) oppure senza alcun imballaggio. Le dimensioni degli articoli non devono superare le seguenti misure massime:

Larghezza: 110 mm  
 Altezza: 25 mm  
 Profondità: 240 mm

**SELF-VENDING dispenser.**

The machine is designed to dispense various items that can be pre-packaged (in rigid or soft casing) or without packaging. The size of the products must not exceed the following maximum dimensions:

Width: 110mm  
 Height: 25 mm  
 Depth: 240 mm

| MOD.                      | PANNOMATIC-N  | SV-96                                       |
|---------------------------|---|---|
| CAPPELLO COVER            | Inox  | Inox  |
| PROGRAMMI PROGRAMS        | Lava vetri e Multiuso, Lucida cruscotti, Fascioni, Panno asciutto<br>Window cleaning, Dashboards polish, Fascias, Dry cloth | /   |
| TENSIONE VOLTAGE          | 230 V   | 230 V                                       |
| POTENZA POWER             | 200 W   | 500W  |
| GETTONIERA COIN VALIDATOR | Elettronica Electronic  | Elettronica Electronic                      |
| PORTE DOORS               | Con serrature semplici<br>With pin tumbler locks  | Con serratura blindata<br>With armored lock |
| PESO WEIGHT               | 80 kg   | 90 kg                                       |



**Opzionali più richiesti**

Tutti gli opzionali si possono visionare a pag. 36

All optionals can be viewed on page 36



KIT BARRE DI SICUREZZA SAFETY BARS KIT

# EROGATORE PRODOTTO BATTERICIDA SANIFICANTE

Antibacterial product dispenser



MOD. EPB-20  
MOD. EPB1-20

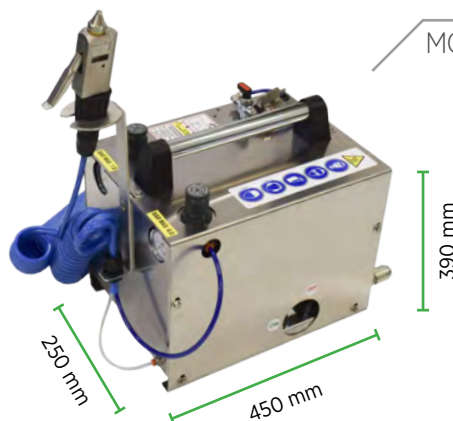

MOD. EPB-P1



MOD. EPB-P20



BRACCIO GIREVOLE  
ROTATING ARM

## Opzionali più richiesti

Tutti gli opzionali si possono visionare a pag. 36  
All optional can be viewed on page 36



| MOD.                                | EPB-20   | EPB1-20  |
|-------------------------------------|--|--|
| CAPPELLO<br>COVER                   | In ABS nero<br>Black   | In ABS nero<br>Black   |
| TIPO DI PRODOTTO<br>TYPE OF PRODUCT | Battericida<br>Antibacterial   | Battericida<br>Antibacterial   |
| COMPRESSORE<br>COMPRESSOR           | Interno<br>Internal  | Non incluso<br>Not included  |
| TENSIONE<br>VOLTAGE                 | 230 V  | 230 V  |
| POTENZA<br>POWER                    | 150 W  | 150 W  |
| LUNGHEZZA TUBO                      | 10 m circa   | 10 m circa   |
| GETTONIERA<br>COIN VALIDATOR        | Elettronica<br>Electronic  | Elettronica<br>Electronic  |
| SERBATOIO<br>TANK                   | 5 L (Interno inox pressurizzato)<br>5 L (Internal pressurized, Inox) | 5 L (Interno inox pressurizzato)<br>5 L (Internal pressurized, Inox) |
| PORTE<br>DOORS                      | Con serrature semplici<br>With pin tumbler locks                     | Con serrature semplici<br>With pin tumbler locks                     |
| PESO<br>WEIGHT                      | 33 kg  | 33 kg  |

|  | EPB-P1   | EPB-P20  |
|--|--|--|
|  | /  | /  |
|  | Battericida portatile<br>Portable antibacterial<br>product dispenser | Battericida portatile<br>Portable antibacterial<br>product dispenser |
|  | Non incluso<br>Not included  | Interno<br>Internal  |
|  | 230 V  | 230 V  |
|  | 500 W  | 500 W  |
|  | 8 m utile  | 8 m utile  |
|  | /  | /  |
|  | 5 L (Interno pressurizzato)<br>5 L (Internal pressurized)            | 5 L (Interno pressurizzato)<br>5 L (Internal pressurized)            |
|  | /  | /  |
|  | 11 kg  | 13 kg  |

# EROGATORE PRODOTTO 1 PROGRAMMA

1 Program Upright Product Dispensers



MOD. EPP  
MOD. EPA\*  
MOD. EPN  
MOD. EPV  
MOD. EPC  
MOD. EPQ



BRACCIO GIREVOLE  
ROTATING ARM

## Opzionali più richiesti

Tutti gli opzionali si possono visionare a pag. 36  
All optionals can be viewed on page 36



PISTOLA INOX PER PRODOTTO  
INOX GUN FOR PRODUCT



\*Per il programma aria compressa è necessario l'arrivo dell'aria da un compressore esterno. La macchina non include il compressore.

\*Please note: air must be brought to the machine by an external air compressor (not included).

| MOD.                                | EPP  | EPA*   | EPN  | EPV  | EPC  | EPQ  |
|-------------------------------------|--|--|--|--|--|--|
| CAPPELLO<br>COVER                   | In ABS nero<br>Black                                   | In ABS nero<br>Black                                   | In ABS nero<br>Black                                   | In ABS nero<br>Black                                   | In ABS nero<br>Black                                   | In ABS nero<br>Black                                   |
| TIPO DI PRODOTTO<br>TYPE OF PRODUCT | Profumo<br>antibatterico<br>Antibacterial scent        | Aria compressa<br>Compressed air                       | Nero gomme<br>Tyre blacking                            | Lava vetri<br>Window cleansing                         | Lucida cruscotti<br>Dashboard polish                   | Acqua<br>Water   |
| COMPRESSORE<br>COMPRESSOR           | /  | Non incluso<br>Not included                            | /  | /  | /  | /  |
| TENSIONE<br>VOLTAGE                 | 230 V  | 230 V  | 230 V  | 230 V  | 230 V  | 230 V  |
| POTENZA<br>POWER                    | 150 W  | 150 W  | 150 W  | 150 W  | 150 W  | 150 W  |
| POMPE<br>PUMPS                      | Standard   | Standard   | Standard   | Standard   | Standard   | Standard   |
| GETTONIERA<br>COIN VALIDATOR        | Elettronica<br>Electronic                              | Elettronica<br>Electronic                              | Elettronica<br>Electronic                              | Elettronica<br>Electronic                              | Elettronica<br>Electronic                              | Elettronica<br>Electronic                              |
| PORTE<br>DOORS                      | Con serrature<br>semplici<br>With pin tumbler<br>locks | Con serrature<br>semplici<br>With pin tumbler<br>locks | Con serrature<br>semplici<br>With pin tumbler<br>locks | Con serrature<br>semplici<br>With pin tumbler<br>locks | Con serrature<br>semplici<br>With pin tumbler<br>locks | Con serrature<br>semplici<br>With pin tumbler<br>locks |
| PESO<br>WEIGHT                      | 25 kg  | 25 kg  | 25 kg  | 25 kg  | 25 kg  | 25 kg  |

# EROGATORE PRODOTTO 2 PROGRAMMI

2 Programs Upright Product Dispensers



| MOD.   | COMBINAZIONI DI PRODOTTO / PRODUCTS COMBINATIONS   |
|--------|--|
| EPDAP* | Aria compressa + Profumo antibatterico<br>Compressed air + Antibacterial scent             |
| EPDAN* | Aria compressa + Nero gomme<br>Compressed air + Tyre blacking                              |
| EPDAV* | Aria compressa + Lava vetri<br>Compressed air + Window cleansing                           |
| EPDAC* | Aria compressa + Lucida cruscotti<br>Compressed air + Dashboard polish                     |
| EPDAQ* | Aria compressa + Acqua<br>Compressed air + Water   |
| EPDAG* | Aria compressa + Gonfia gomme<br>Compressed air + Tyre inflator                            |
| EPDPP  | Profumo antibatterico + Profumo antibatterico<br>Antibacterial scent + Antibacterial scent |
| EPDPN  | Profumo antibatterico + Nero gomme<br>Antibacterial scent + Tyre blacking                  |
| EPDPV  | Profumo antibatterico + Lava vetri<br>Antibacterial scent + Window cleansing               |
| EPDPC  | Profumo antibatterico + Lucida cruscotti<br>Antibacterial scent + Dashboard polish         |
| EPDPQ  | Profumo antibatterico + Acqua<br>Antibacterial scent + Water                               |
| EPDPG* | Profumo antibatterico + Gonfia gomme<br>Antibacterial scent + Tyre inflator                |
| EPDNV  | Nero gomme + Lava vetri<br>Tyre blacking + Window cleansing                                |
| EPDNC  | Nero gomme + Lucida cruscotti<br>Tyre blacking + Dashboard polish                          |
| EPDNQ  | Nero gomme + Acqua<br>Tyre blacking + Water  |
| EPDNG* | Nero gomme + Gonfia gomme<br>Tyre blacking + Tyre inflator                                 |
| EPDVC  | Lava vetri + Lucida cruscotti<br>Window cleansing + Dashboard polish                       |
| EPDVQ  | Lava vetri + Acqua<br>Window cleansing + Water   |
| EPDVG* | Lava vetri + Gonfia gomme<br>Window cleansing + Tyre inflator                              |
| EPDCQ  | Lucida cruscotti + Acqua<br>Dashboard polish + Water                                       |
| EPDCG* | Lucida cruscotti + Gonfia gomme<br>Dashboard polish + Tyre inflator                        |
| EPDQG* | Acqua + Gonfia gomme<br>Water + Tyre inflator  |



\* Per i programmi Aria compressa e Gonfia gomme è necessario l'arrivo dell'aria da un compressore esterno.



La macchina non include il compressore.

\* Please note: air must be brought to the machine by an external air compressor (not included).

## Opzionali più richiesti

Tutti gli opzionali si possono visionare a pag. 36

All optional can be viewed on page 36



BRACCIO GIREVOLE  
ROTATING ARM

|                           |  |
|---------------------------|--|
| CAPPELLO COVER            | In ABS nero<br>Black ABS                         |
| TENSIONE VOLTAGE          | 230 V  |
| POTENZA POWER             | 200 W  |
| GETTONIERA COIN VALIDATOR | Elettronica<br>Electronic                        |
| POMPE PUMPS               | Standard   |
| PORTE DOORS               | Con serrature semplici<br>With pin tumbler locks |
| PESO WEIGHT               | 25 Kg  |

## EROGATORE PRODOTTO 3 PROGRAMMI e 4 PROFUMI

3 Programs Upright Product and 4 Essences Dispensers



MOD. EPT\*  
MOD. EPT-1\*



MOD. 4E  
MOD. 4ES



\*Per il programma aria compressa è necessario l'arrivo dell'aria da un compressore esterno. La macchina non include il compressore.

\*Please note: air must be brought to the machine by an external air compressor (not included).



BRACCIO GIREVOLE  
ROTATING ARM

### Opzionali più richiesti

Tutti gli opzionali si possono visionare a pag. 36

All optional can be viewed on page 36

| MOD.                      | EPT   | EPT-1   | 4E   | 4ES  |
|---------------------------|---|---|--|--|
| CAPPELLO COVER            | In ABS nero<br>Black ABS  | In ABS nero<br>Black ABS  | Inox   | Inox   |
| PROGRAMMI PROGRAMS        | Aria compressa + Profumo antibatterico + Nero gomme<br>Compressed air + Antibacterial scent + Tyre blacking | Aria compressa + Profumo antibatterico + Nero gomme<br>Compressed air + Antibacterial scent + Tyre blacking | 4 Profumi<br>4 Essences                          | 4 Profumi<br>4 Essences                          |
| TENSIONE VOLTAGE          | 230 V   | 230 V   | 230 V  | 230 V  |
| POTENZA POWER             | 200 W   | 200 W   | 200 W  | 200 W  |
| POMPE PUMPS               | Standard + Inox per profumo<br>Standard + Inox for perfume  | Standard  | Standard   | Inox   |
| GETTONIERA COIN VALIDATOR | Elettronica<br>Electronic   | Elettronica<br>Electronic   | Elettronica<br>Electronic                        | Elettronica<br>Electronic                        |
| PORTE DOORS               | Con serrature semplici<br>With pin tumbler locks  | Con serrature semplici<br>With pin tumbler locks  | Con serrature semplici<br>With pin tumbler locks | Con serrature semplici<br>With pin tumbler locks |
| PESO WEIGHT               | 25 kg   | 25 kg   | 25 kg  | 25 kg  |

# SOFFIATORE A COLONNA e ASCIUGAMACCHINA-MOTO

*Upright Dispenser Blower and Car-dryer & Motorbike-dryer*



| MOD.                      | SOF/17   | ASM  | ASM-M  |
|---------------------------|--|--|--|
| CAPPELLO COVER            | Inox   | In ABS nero<br>Black ABS                         | In ABS nero<br>Black ABS                         |
| VERSIONE VERSION          | /  | Trifase<br>Three-phase                           | Monofase<br>Mono-phase                           |
| PRESSIONE PRESSURE        | 75 mbar  | /  | /  |
| TENSIONE VOLTAGE          | 400 V  | 400 V  | 230 V  |
| POTENZA POWER             | 400 W  | 2.2 kW   | 1.5 kW   |
| GETTONIERA COIN VALIDATOR | Elettronica<br>Electronic                        | Elettronica<br>Electronic                        | Elettronica<br>Electronic                        |
| PORTE DOORS               | Con serrature semplici<br>With pin tumbler locks | Con serrature semplici<br>With pin tumbler locks | Con serrature semplici<br>With pin tumbler locks |
| PESO WEIGHT               | 67 kg  | 66 kg  | 66 kg  |

# SCHIUMOGENO e PRODOTTO CERCHI

Foam Machine and Product for Rims

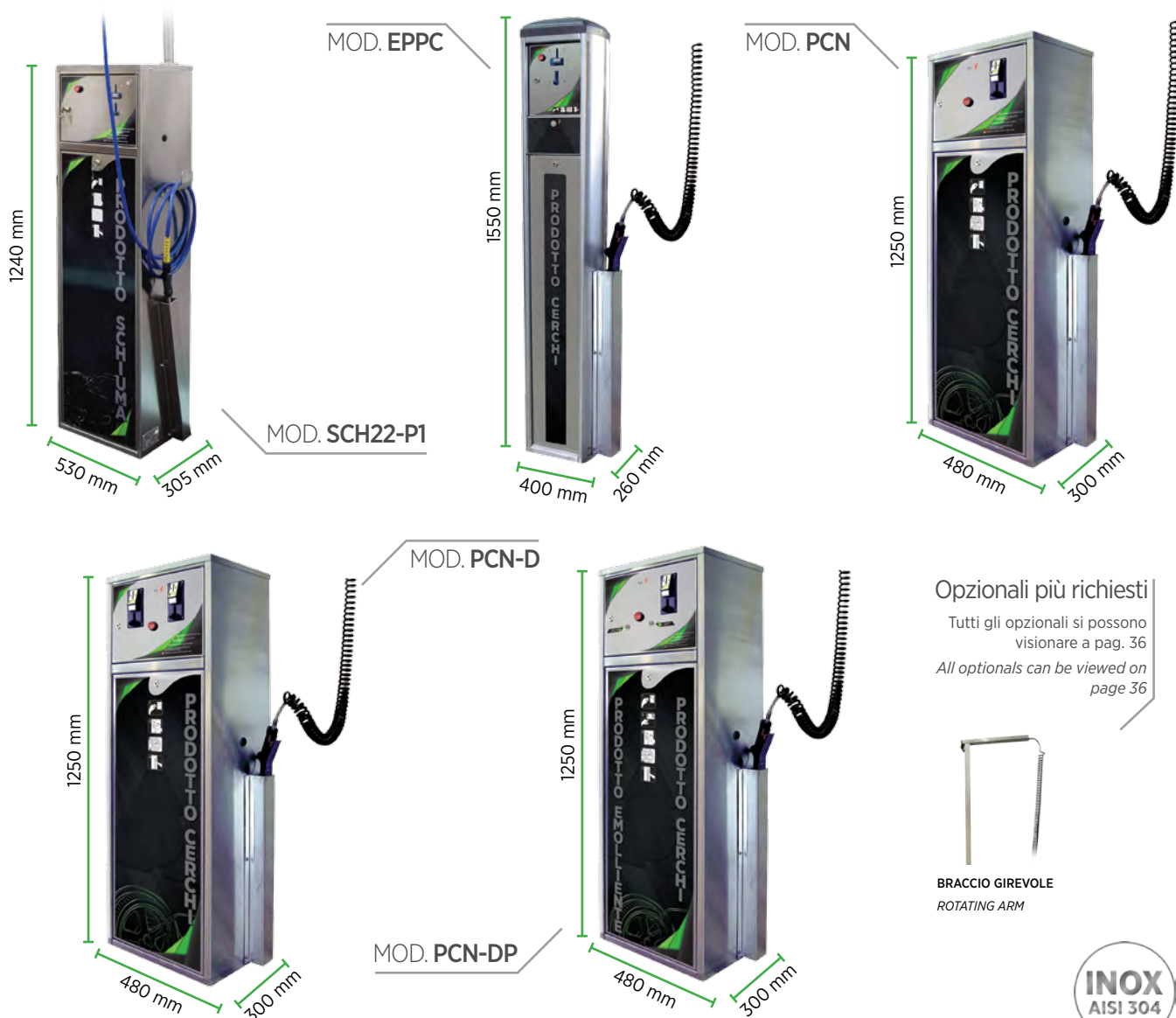

### Opzionali più richiesti

Tutti gli opzionali si possono visionare a pag. 36  
All optional can be viewed on page 36

BRACCIO GIREVOLE  
ROTATING ARM



| MOD.                      | SCH22-P1   | EPPC   | PCN  | PCN-D  | PCN-DP   |
|---------------------------|--|--|--|--|--|
| CAPPELLO COVER            | Inox   | In ABS nero<br>Black ABS                           | Inox   | Inox   | Inox   |
| VERSIONE VERSION          | Prodotto schiuma<br>Foam machine                 | Prodotto cerchi singolo<br>Single product for rims | Prodotto cerchi singolo<br>Single product for rims | Prodotto cerchi doppio<br>(con 2 gettoniere)<br>Double product for rims<br>(with 2 coin validator) | Doppio (Prodotto cerchi + Emolliente)<br>Double (Product for rims + Emollient) |
| TENSIONE VOLTAGE          | 230V   | 230 V  | 230 V  | 230 V  | 230 V  |
| POTENZA POWER             | 200W   | 150 W  | 200 W  | 200 W  | 200 W  |
| SERBATOIO TANK            | 25 L   | 5 L  | 25 L   | 25 L (unico)<br>25 L (unique)  | 2 x 10 L   |
| GETTONIERA COIN VALIDATOR | Elettronica<br>Electronic                        | Elettronica<br>Electronic                          | Meccanica<br>Mechanical                            | Meccanica<br>Mechanical  | Meccanica<br>Mechanical  |
| PORTE DOORS               | Con serrature semplici<br>With pin tumbler locks | Con serrature semplici<br>With pin tumbler locks   | Con serrature semplici<br>With pin tumbler locks   | Con serrature semplici<br>With pin tumbler locks   | Con serrature semplici<br>With pin tumbler locks                               |
| PESO WEIGHT               | 48 kg  | 25 kg  | 32 kg  | 32 kg  | 32 kg  |



# DETERGI CRISTALLI

## Wind Shield Liquid Dispenser



MOD. DETERGI-I

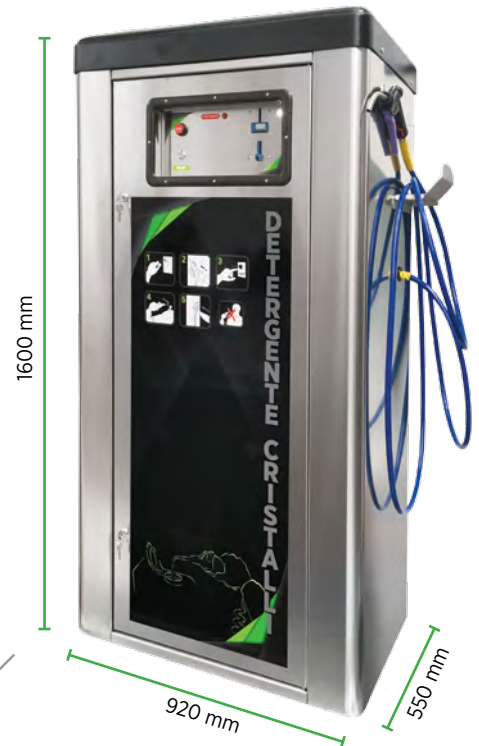

MOD. DETERGI-V

Studiate per erogare un liquido adatto alla pulizia di vetri (tergicristalli) delle autovetture. Queste macchine sono state progettate per riempire le vaschette dei tergicristalli in quantità misurata, con una tolleranza del 5% (es. €1=1L). Il liquido deve avere tutte le caratteristiche adatte alle vaschette dei tergicristalli delle autovetture (es. tolleranza gelo, privo di calcare ecc.)

*These machines are designed to dispense an appropriate liquid for car window cleaning (wiper blades) by filling wiper blade tank in a proportionate quantity at a tolerance of 5%. All the features of the dispensed liquid must be suitable for the wind shield wipers, such as the absence of calcium and frost tolerance.*



| MOD.                      | DETERGI-I  | DETERGI-V   |
|---------------------------|--|---|
| CAPPELLO COVER            | Inox   | In ABS nero<br>Black ABS  |
| TENSIONE VOLTAGE          | 230 V  | 230 V   |
| POTENZA POWER             | 200 W  | 200 W   |
| POMPA * PUMPS             | Inclusa (da posizionare all'esterno)<br>Included (it must be placed outside)         | Inclusa (montata internamente)<br>Included (it is mounted inside) |
| SERBATOIO TANK            | Non incluso (da posizionare all'esterno)<br>Not included (it must be placed outside) | 120 L   |
| GETTONIERA COIN VALIDATOR | Elettronica<br>Electronic  | Elettronica<br>Electronic   |
| PORTE DOORS               | Con serrature semplici<br>With pin tumbler locks                                     | Con serrature semplici<br>With pin tumbler locks                  |
| PESO WEIGHT               | 50 kg  | 80 kg   |

# GONFIA GOMME OMOLOGATI

Homologated Upright Tyre Inflator



Strumento metrico, che verifica in maniera precisa la pressione dei pneumatici delle vetture. Il gonfia gomme viene sottoposto a verifica, da parte dell'ufficiale metrico nazionale. Tutti i gonfia gomme necessitano di collegamento con un compressore esterno.

**⚠** \*Possibilità di integrare il compressore come opzionale.

*Metric tool that checks the precise pressure of tires. The tyre inflator is checked by the national metric official. Every tyre inflator must be brought to external air compressor.*

**\*By request air compressor can be set inside the machine.**

## Opzionali più richiesti

Tutti gli opzionali si possono visionare a pag. 36

*All options can be viewed on page 36*



**BRACCIO GIREVOLE**  
ROTATING ARM

| MOD.                      | GCP-80   | GCP-160  | GGO80*   | GGO160*  |
|---------------------------|--|--|--|--|
| CAPPELLO COVER            | In ABS nero<br>Black                             | In ABS nero<br>Black                             | In ABS nero<br>Black                             | In ABS nero<br>Black                             |
| COMPRESSORE COMPRESSOR    | Non incluso<br>Not included                      | Non incluso<br>Not included                      | Non incluso *<br>Not included *                  | Non incluso *<br>Not included *                  |
| MANOMETRO MANOMETER       | Ø 80 mm  | Ø 160 mm   | Ø 80 mm  | Ø 160 mm   |
| TENSIONE VOLTAGE          | 230 V  | 230 V  | 230 V  | 230 V  |
| POTENZA POWER             | 500 W  | 500 W  | 500 W  | 500 W  |
| COMANDO CONTROL           | Comando a pannello<br>Panel control              | Comando a pannello<br>Panel control              | Comando a pannello<br>Panel control              | Comando a pannello<br>Panel control              |
| GETTONIERA COIN VALIDATOR | Elettronica<br>Electronic                        | Elettronica<br>Electronic                        | Elettronica<br>Electronic                        | Elettronica<br>Electronic                        |
| PORTA DOOR                | Con serrature semplici<br>With pin tumbler locks | Con serrature semplici<br>With pin tumbler locks | Con serrature semplici<br>With pin tumbler locks | Con serrature semplici<br>With pin tumbler locks |
| PESO WEIGHT               | 25 kg  | 25 kg  | 42 kg  | 42 kg  |



# GONFIA GOMME Mod. G e DIGITALE

Mod. G and Digital Upright Tyre Inflator



## Opzionali più richiesti

Tutti gli opzionali si possono visionare a pag. 36

All optional can be viewed on page 36



BRACCIO GIREVOLE  
ROTATING ARM

Tutti i gonfia gomme necessitano di collegamento con un compressore esterno.



**\*Possibilità di integrare il compressore come opzionale.**

*Every tyre inflator must be brought to external air compressor.*

**\*By request air compressor can be set inside the machine.**



| MOD.                         | GEP/19   | GC   | G*   |
|------------------------------|--|--|--|
| CAPPELLO<br>COVER            | Inox   | In ABS nero<br>Black                             | In ABS nero<br>Black                             |
| COMPRESSORE<br>COMPRESSOR    | Non incluso<br>Not included                      | Non incluso<br>Not included                      | Non incluso *<br>Not included *                  |
| MANOMETRO<br>MANOMETER       | Ø 80 mm  | Su pistola<br>On gun                             | Su pistola<br>On gun                             |
| TENSIONE<br>VOLTAGE          | 230 V  | 230 V  | 230 V  |
| POTENZA<br>POWER             | 500 W  | 500 W  | 500 W  |
| COMANDO<br>CONTROL           | Settaggio digitale<br>Digital display control    | Comando a pistola<br>Gun control                 | Comando a pistola<br>Gun control                 |
| GETTONIERA<br>COIN VALIDATOR | Elettronica<br>Electronic                        | Elettronica<br>Electronic                        | Elettronica<br>Electronic                        |
| PORTA<br>DOOR                | Con serrature semplici<br>With pin tumbler locks | Con serrature semplici<br>With pin tumbler locks | Con serrature semplici<br>With pin tumbler locks |
| PESO<br>WEIGHT               | 41 kg  | 24 kg  | 42 kg  |

# GONFIA GOMME OMOLOGATO A MURO

*On Wall Homologated Tyre Inflator*

MOD. GGIP0160



Necessita di collegamento con un compressore esterno.

*Air must be brought to machine by external air compressor.*



| MOD.                                | GGIP080                                 | GGIP0160                                |
|-------------------------------------|---|---|
| COMPRESSORE<br><i>COMPRESSOR</i>    | Non incluso<br><i>Not included</i>      | Non incluso<br><i>Not included</i>      |
| MANOMETRO<br><i>MANOMETER</i>       | Ø 80 mm                                 | Ø 160 mm                                |
| TENSIONE<br><i>VOLTAGE</i>          | 230 V                                   | 230 V                                   |
| POTENZA<br><i>POWER</i>             | 500 W                                   | 500 W                                   |
| VERSIONE<br><i>VERSION</i>          | Fissaggio a muro<br><i>Wall setting</i> | Fissaggio a muro<br><i>Wall setting</i> |
| GETTONIERA<br><i>COIN VALIDATOR</i> | Elettronica<br><i>Electronic</i>        | Elettronica<br><i>Electronic</i>        |
| PESO<br><i>WEIGHT</i>               | 30 kg                                   | 30 kg                                   |

## MACCHINE COMBinate

Combined Machines



MOD. LI-SEA1  
MOD. LI-SEA2  
MOD. LI-SEA3  
MOD. LI-SEA4

MOD. ADOOSA-GG160



| MOD.                             | LI-SEA1  | LI-SEA2   | LI-SEA3  | LI-SEA4   | ADOOSA-GG160   |
|----------------------------------|--|---|--|---|--|
| <b>CAPPELLO COVER</b>            | In ABS nero<br>Black   | In ABS nero<br>Black  | In ABS nero<br>Black   | In ABS nero<br>Black  | In ABS nero<br>Black   |
| <b>PROGRAMMI PROGRAMS</b>        | Lavainterni schiuma +<br>Aspirapolvere<br>Foam Interiors cleaner +<br>vacuum cleaner | Lavainterni estrazione +<br>Aspirapolvere<br>Extraction Interiors<br>cleaner + vacuum cleaner | Lavainterni schiuma +<br>Aspirapolvere<br>Foam Interiors cleaner +<br>vacuum cleaner | Lavainterni estrazione +<br>Aspirapolvere<br>Extraction Interiors<br>cleaner + vacuum cleaner | Aspirapolvere + Gonfia<br>gomme<br>Vacuum cleaner + Tyre<br>Inflator |
| <b>FILTRO FILTER</b>             | Classico<br>Classic  | Classico<br>Classic   | Autopulente<br>Self-cleaning   | Autopulente<br>Self-cleaning  | Autopulente<br>Self-cleaning   |
| <b>TENSIONE VOLTAGE</b>          | 400 V  | 400 V   | 400 V  | 400 V   | 400 V  |
| <b>POTENZA POWER</b>             | 2.2 kW x2  | 2.2 kW x2   | 2.2 kW x2  | 2.2 kW x2   | 2.2 kW   |
| <b>MANOMETRO MANOMETER</b>       | /  | /   | /  | /   | Ø 160 mm   |
| <b>GETTONIERA COIN VALIDATOR</b> | Elettronica<br>Electronic  | Elettronica<br>Electronic   | Elettronica<br>Electronic  | Elettronica<br>Electronic   | Elettronica<br>Electronic  |
| <b>PORTA DOOR</b>                | Con serratura blindata<br>With armored lock  | Con serratura blindata<br>With armored lock   | Con serratura blindata<br>With armored lock  | Con serratura blindata<br>With armored lock   | Con serratura blindata<br>With armored lock                          |
| <b>PESO WEIGHT</b>               | 150 kg   | 150 kg  | 150 kg   | 150 kg  | 125 kg   |

## MACCHINE COMBinate

### Combined Machines

Le macchine combinate AD sono macchine speciali, progettate su misura per le esigenze del cliente.

I modelli di macchine proposti di seguito sono **esemplificativi** delle diverse possibilità di combinazione dei prodotti offerti da A.D. Produzione. Per la configurazione completa della Vostra macchina, vi invitiamo per tanto a contattare direttamente il nostro ufficio commerciale per concordare insieme la combinazione di funzioni più adatta alle specifiche esigenze.

The AD combined machines are special machines, these are designed to meet the needs of the customer.

The following models of machines are **examples** of the different possibilities of combining the products offered by A.D. Production. For the complete configuration of your machine, we invite you to contact our export sales department directly, to agree together the best combination of functions for your specific needs.



**Esempio di macchina combinata:**

Programmi: Soffiatore + Gonfia gomme + Nero gomme

**Examples of combined machine:**

Programs: Blower + Tyre inflator + Tyre blacking

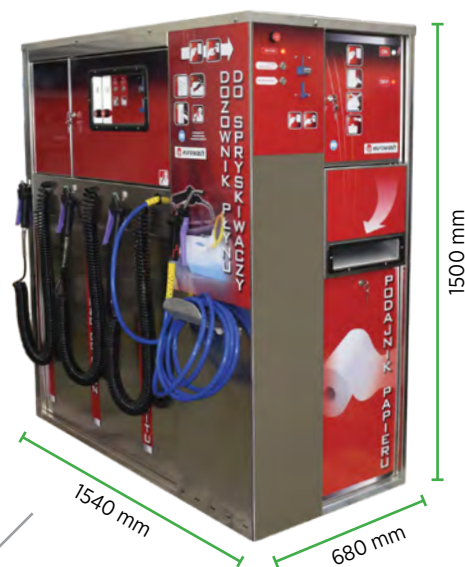

**Esempio di macchina combinata:**

Programmi: Detergente cristalli + Distributore carta + Nero gomme + Profumo + Lucida cruscotti

**Examples of combined machine:**

Programs: Window cleansing + Paper dispenser + Tyre blacking + Antibacterial Scent + Dashboard polish



**Esempio di macchina combinata:**

Programmi: Aspirapolvere + Aria compressa + Nero gomme + Profumo + PANNOMATIC

**Examples of combined machine:**

Programs: Vacuum cleaner + Compressed air + Tyre blacking + Perfume + PANNOMATIC

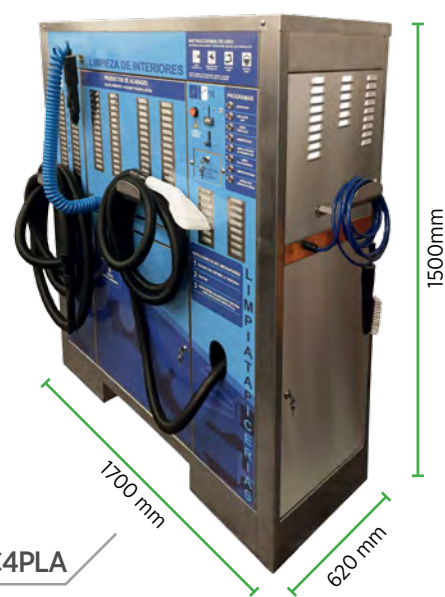

**Esempio di macchina combinata:**

Programmi: Aspirapolvere + Aria compressa + Lavavetri + Nero gomme + Profumo + Lavainterni + Lucida cruscotti

**Examples of combined machine:**

Programs: Vacuum cleaner + Compressed air + Window cleaning + Tyre blacking + Perfume + Interiors cleaner + Dashboard polish

# SPREMIPELLE

Leather Squeezer

MOD. SPC21E



MOD. SPC21M



MOD. SPR19



MOD. SP19

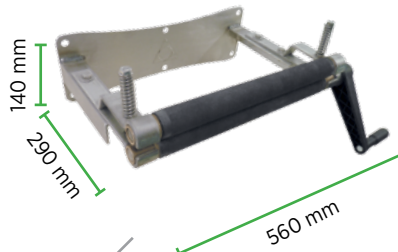

MOD. SPM-N

### Opzionali più richiesti

Tutti gli opzionali si possono visionare a pag. 36  
All optionals can be viewed on page 36



KIT APEDALE ELETTRICO  
ELECTRIC PEDAL KIT

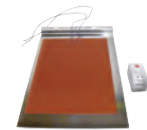

KIT ANTIGELO CON TERMOSTATO E TERMORESISTENZA  
ANTIFREEZE KIT WITH THERMISTOR AND THERMOSTAT



| MOD.                               | SPC21E   | SPC21M   | SPR19  | SP19   | SPM-N             |
|------------------------------------|--|--|--|--|-------------------|
| VERSIONE<br>VERSION                | A cascata<br>Cascade                             | A cascata<br>Cascade                             | A rubinetto<br>With tap                          | A colonna<br>Upright                             | A muro<br>On wall |
| EROGAZIONE ACQUA<br>WATER DELIVERY | Si<br>Yes  | Si<br>Yes  | Si<br>Yes  | No   | No                |
| PEDALE<br>PEDAL                    | Elettrico<br>Electric                            | Meccanico<br>Mechanical                          | Meccanico<br>Mechanical                          | No   | No                |
| PORTA<br>DOOR                      | Con serrature semplici<br>With pin tumbler locks | Con serrature semplici<br>With pin tumbler locks | Con serrature semplici<br>With pin tumbler locks | Con serrature semplici<br>With pin tumbler locks | /                 |
| PESO<br>WEIGHT                     | 25 kg  | 25 kg  | 20 kg  | 20 kg  | 7 kg              |

## NEBULIZZATORI Nebulizer



I nebulizzatori sono dispositivi utili alla nebulizzazione (atossica) di detergenti liquidi adatti al lavaggio di automezzi. I nebulizzatori mostrati in questa pagina sono realizzati in acciaio inox ed il loro relativo serbatoio include l'indicatore di livello. Funzionamento pneumatico. Dotato di tubo da 10 m, lancia in acciaio inox LC-2 con ugello spray e protezione ugello.

*The nebulizers are a useful equipment for the no-toxic atomization of liquid detergents. It is suitable for washing vehicles. The nebulizers shown on this page are made of stainless steel and its tank includes the level indicator. Pneumatically operating. Equipped with an hose length 10 mt, LC-2 stainless steel lance with spray nozzle and nozzle protection.*

| MOD.  | CEN57                                    | CEN58                                    |
|---|--|--|
| CAPACITÀ<br>CAPACITY                                      | 25 L                                     | 50 L                                     |
| MAX LIQUIDO<br>LIQUID MAX                                 | 19 L                                     | 40 L                                     |
| PRESSIONE<br>PRESSURE                                     | 8 bar                                    | 8 bar                                    |
| TUBO USCITA LIQUIDO<br>HOSE FORE LIQUID EXIT              | Treccia rilsan 7 m<br>Rilsan 7 m         | Treccia rilsan 10 m<br>Rilsan 10 m       |
| INGRESSO ARIA COMPRESSA<br>COMPRESSED AIR ENTRANCE        | 1/4" gas femmina<br>1/4" gas             | 1/4" gas femmina<br>1/4" gas             |
| TAPPO DI CARICO LIQUIDO<br>TOP FOR LIQUID LOAD            | Ottone inox<br>Brass and stainless steel | Ottone inox<br>Brass and stainless steel |
| PESO NETTO<br>NET WEIGHT                                  | 11.3 kg                                  | 17.5 kg                                  |
| PESO LORDO<br>GROSS WEIGHT                                | 13 kg                                    | 19.5 kg                                  |
| INDICATORE DI LIVELLO IN RILSAN<br>RILSAN LEVEL INDICATOR | Si<br>Yes                                | Si<br>Yes                                |



# CESTINI PORTARIFIUTI

## Waste Basket



**!** \* Necessario fissare il cestino al muro o su altro supporto.  
 \* It is necessary to fix the basket on the wall or on another support.

### Opzionali più richiesti

Tutti gli opzionali si possono visionare a pag. 36  
 All optionals can be viewed on page 36



POSACENERE INOX  
 STAINLESS STEEL ASHTRY



| MOD.                             | CPR                  | CPR19      | CPR21      | CPR3-N     | CPRM*      |
|----------------------------------|----------------------|------------|------------|------------|------------|
| CAPPELLO COVER                   | In ABS nero<br>Black | Inox       | Inox       | Inox       | Inox       |
| PESO WEIGHT                      | 25 kg                | 21.5 kg    | 21.5 kg    | 65 kg      | 7 kg       |
| BASCULANTE (BxA) TILTING OPENING | 250x180 mm           | 250x118 mm | 150x100 mm | 250x180 mm | 150x100 mm |

## SBATTITAPPETI E ACCESSORI

*Carpets Beater and Accessories*



MOD. BCI

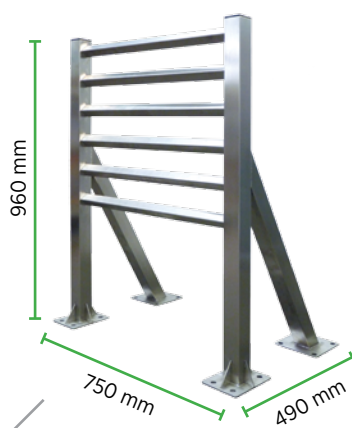

MOD. BX-P

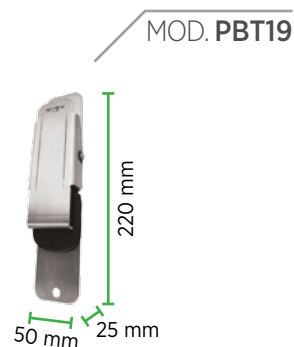

MOD. PBT19

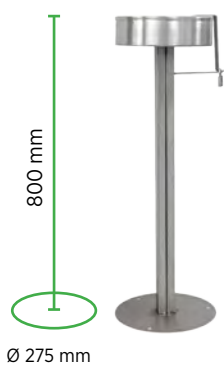

MOD. PSC

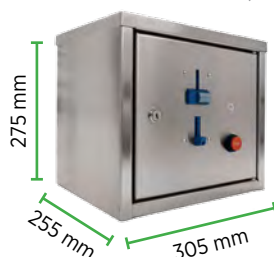

MOD. CS01

Questo apparecchio è stato studiato per permettere di trasformare le macchine no-self (es. idropulitrici) in SELF-SERVICE, mediante l'utilizzo della gettoniera. Questo accessorio viene utilizzato per le macchine che non appartengono alla linea A.D. Produzione.

*This device has been designed to convert no-self machine in SELF-SERVICE equipments thanks to the token-operated. This device is not used for A.D. Produzione machines, but for other equipments (like pressure washers).*



| MOD.                         | BCI   | BX-P  | PBT19  | PSC                          | CS01  |
|------------------------------|---|---|--|------------------------------|---|
| VERSIONE<br>VERSION          | Sbattitapeto con cassetto per raccolta polveri<br><i>Carpets beater with drawer to collect dust</i> | Sbattitapeto a griglia<br><i>Carpets beater with grid</i> | Pinza blocca-tappeti<br><i>Clamp hang-mats</i> | Posacenere<br><i>Ashtray</i> | Comando self per macchine ausiliarie<br><i>Self-control for auxiliary machine</i> |
| GETTONIERA<br>COIN VALIDATOR | /   | /   | /  | /                            | Elettronica<br><i>Electronic</i>  |
| TENSIONE<br>VOLTAGE          | /   | /   | /  | /                            | 230 - 400 v   |
| PESO<br>WEIGHT               | 30 kg   | 30 kg   | 0.4 kg   | 5 kg                         | 5 kg  |

# PORTALANCIA E PORTASPAZZOLA

Lance holder & brush bucket

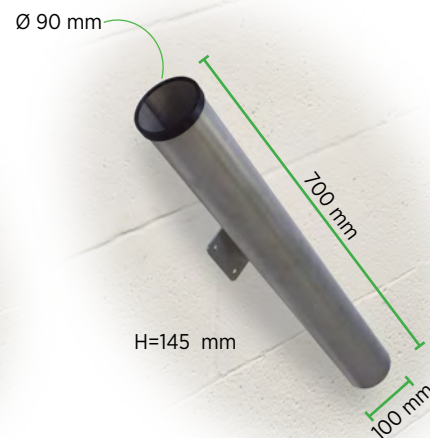
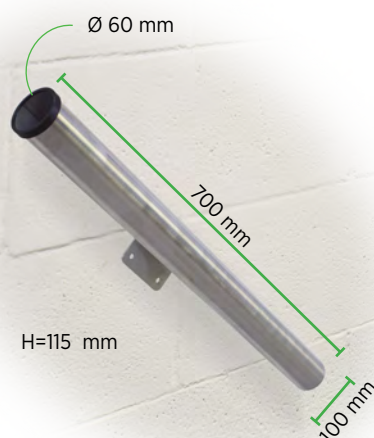
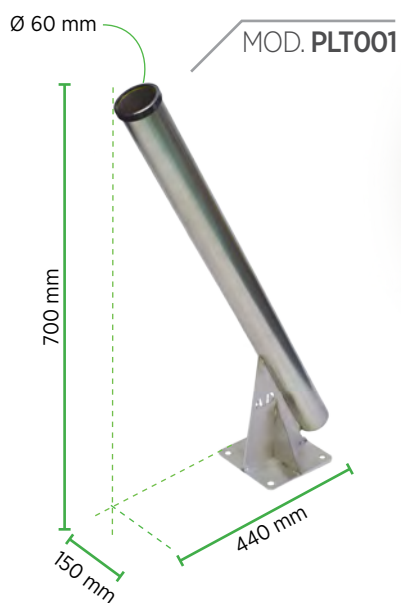

MOD. PLP001

MOD. PLP002

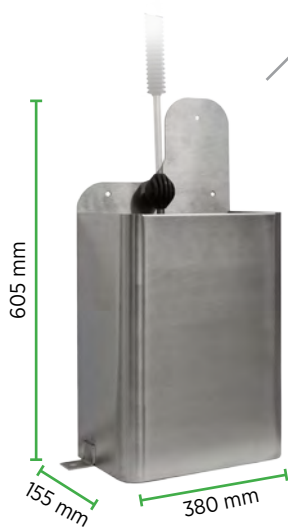
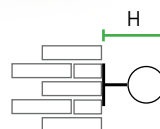

MOD. PS001

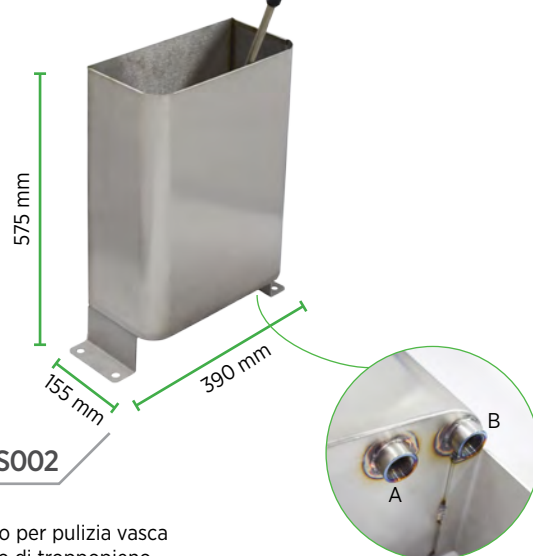

MOD. PS002

A = Scarico per pulizia vasca  
B = Scarico di troppopieno

A = Drain for tank cleaning  
B = Overflow



| MOD.                | PLT001  | PLP001  | PLP002   | PS001                                  | PS002                               |
|---------------------|---|---|--|--|-------------------------------------|
| VERSIONE<br>VERSION | Portalanca con fissaggio a terra<br>Lance holder, floor mounted | Portalanca piccolo con fissaggio a parete<br>Small lance holder, wall mounted | Portalanca grande con fissaggio a parete<br>Large lance holder, wall mounted | Cestello portaspazzola<br>Brush bucket | Vasca portaspazzola<br>Brush bucket |
| PESO<br>WEIGHT      | 2.6 kg  | 2 kg  | 3.5 kg   | 4.7 kg                                 | 5 kg                                |

## OPZIONALI Optionals

### MC0142/A

KIT LETTORE CHIAVE  
EUROKEY NEXT  
EUROKEY NEXT  
READER KIT



### C.M.000

KIT COMANDO MANUALE  
MANUAL START BUTTON KIT



### PG01

CASSETTO GETTONI  
PER GETTONIERE  
COIN GATHERING BOX  
FOR COIN VALIDATOR



### KGE001

KIT GETTONIERA  
ELETTRONICA  
COIN VALIDATOR KIT



### CG01

COPERTURA GETTONIERA  
ELETTRONICA INTERNA  
INTERNAL COVER FOR COIN  
VALIDATOR



### CG02

COPERTURA GETTONIERA  
ELETTRONICA ESTERNA  
EXTERNAL COVER FOR COIN  
VALIDATOR



### MC0221

PISTOLA INOX PER PRODOTTO  
INOX GUN FOR PRODUCT



### KVAC001

KIT ALLARME ANOMALIA CON  
LAMPEGGIANTE  
ANOMALY ALARM KIT WITH  
FLASHING LIGHT



Per aspirapolveri e lavainterni  
For vacuum cleaners and Interiors cleaner

### SL

SOLLEVATUBO A COLONNA  
UPRIGHT PIPE LIFTER



Per aspirapolveri e lavainterni  
For vacuum cleaners and Interiors cleaner

### SLM

SOLLEVATUBO A MOLLA  
SPRING PIPE LIFTER



Per aspirapolveri e lavainterni  
For vacuum cleaners and Interiors cleaner

### K.SILENT.INT

SILENZIATORE INTERNO PER  
ASPIRATORE  
INTERNAL NOISE REDUCER



Per aspirapolveri e lavainterni  
For vacuum cleaners and Interiors cleaner

### ASCX021

SILENZIATORE ESTERNO  
EXTERNAL NOISE REDUCER



Per aspirapolveri e lavainterni  
For vacuum cleaners and Interiors cleaner

### K.B.AP.01

KIT BATTERICIDA A.P. SENZA  
COMPRESSORE  
HIGH PRESSURE ANTI BACTERIAL  
KIT (AIR COMPRESSOR NOT  
INCLUDED)

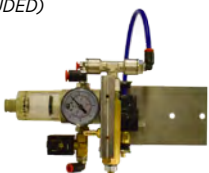

Per lavainterni  
For Interiors cleaner

### K.B.AP.

KIT BATTERICIDA A.P. CON  
COMPRESSORE  
HIGH PRESSURE ANTI BACTERIAL  
KIT (AIR COMPRESSOR  
INCLUDED)

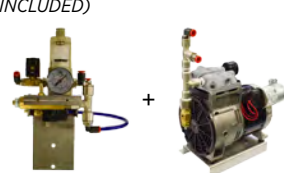

Per lavainterni  
For Interiors cleaner

### KAS

KIT ANTIGELO CON  
TERMORESISTENZA  
ANTIFREEZE KIT WITH THERMISTOR



Per lavatappeti e spremipelle  
For car-mats washers and leather squeezer

### KAST

KIT ANTIGELO CON TERMOSTATO  
E TERMORESISTENZA  
ANTIFREEZE KIT WITH THERMISTOR  
AND THERMOSTAT

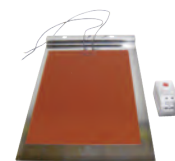

Per lavatappeti e spremipelle  
For car-mats washers and leather squeezer

**AP.01**

APPOGGIA TAPPETO LATERALE  
LATERAL MAT-FRAME

**AP.02**

APPOGGIA TAPPETO SUPERIORE  
SUPERIOR MAT-FRAME

**K.M.D.**

KIT BATTERICIDA  
BACTERICIDE KIT



Per lavatappeti  
For car-mats washers

**ID0064/B**

POMPA INOX PER COLONNE  
PRODOTTO  
INOX PUMP FOR UPRIGHT  
DISPENSER

**ASM-P**

PALO PER BRACCIO  
ARM SUPPORT POLE



Per Aspirapolveri e Asciugamacchine  
For Vacuum-Cleaner and Car Dryer

**ASM-B**

BRACCIO GIREVOLE  
ROTATING ARM



Per Aspirapolveri e Asciugamacchine  
For Vacuum-Cleaner and Car Dryer

**ASM-001**

BILANCIATORE A MOLLA  
SPRING BALANCER

**ASM-002**

TUBO A GOMITO CON FASCETTA  
PIPE WITH A BEND

**BGS**

BRACCIO GIREVOLE  
ROTATING ARM



Per prodotto cerchi e colonnine  
For product for rims and upright dispenser

**MC0222**

PISTOLA INOX PRODOTTO  
CERCHI E SCHIUMA  
INOX GUN FOR RIMS' PRODUCT  
AND FOAM MACHINE

**CGG**

COMPRESSORE INTERNO 1,5 kW  
1,5 kW INTERNAL COMPRESSOR



Per gonfia gomme mod. G e GGO  
For tyre inflators G and GGO mod.

**AGG**

ARROTOLATORE  
SELF-RETRACTING HOSE REEL



Per gonfia gomme  
For tyre inflators

**K.GCA/80**

KIT GONFIA GOMME Ø 80  
Ø 80 TYRE INFLATOR KIT

**K.GCA/160**

KIT GONFIA GOMME Ø 160  
Ø 160 TYRE INFLATOR KIT

**KIT LED**

LUCE LED  
LED LAMP



Per gonfia gomme  
For tyre inflators

**K.PE.SPC**

KIT PEDALE  
ELETTRICO  
ELECTRIC PEDAL KIT



Per spremipelle  
For leather squeezer

## PSCT

POSACENERE INOX  
STAINLESS STEEL ASHTRY



Per cestini portarifiuti  
For waste basket

**KARA-01** Aria compressa con turbina trifase  
*Compressed air with turbine three-phase*

**KARA-02** Aria compressa con turbina monofase  
*Compressed air with turbine mono-phase*

**KARA** Aria compressa  
*Compressed air*

**K.P.A** Profumo antibatterico  
*Antibacterial scent*

**K.N.A** Nero gomme  
*Tyre blacking*

**K.C.A** Lucida cruscotti  
*Dashboard polish*

**K.G.A** Manometro su pistola  
*Homologated gun for tyre inflator*

**K.Q.A** Acqua  
*Water*

**K.L.A** Lava vetri  
*Window cleansing*



## KIT PRODOTTO

PRODUCT KIT

**KSB-001** Per aspiratore singolo U2011/ECO/AD  
*For single vacuum-cleaner U2011/ECO/AD*

**KSB-002** Per aspiratore singolo TO  
*For single vacuum-cleaner TO*

**KSB-003** Per aspiratore doppio U2011/ECO/AD  
*For double vacuum-cleaner U2011/ECO/AD*

**KSB-004** Per aspiratore 4 programmi  
*For 4 programs vacuum-cleaner*

**KSB-005** Per lavainterni  
*For interiors cleaner*

**KSB-006** Per lavatappeti  
*For car-mats washer*

**KSB-007** Per colonnine prodotto (dim. base 35x26 cm)  
*For upright product dispensers (base dim. 35x26 cm)*

**KSB-008** Per detergente vetri grande  
*Big crystal cleansing liquid dispenser*

**KSB-009** Per distributori di panno  
*For towel dispensers*

**KSB-010** Per sanificante caschi  
*For hygienic machine for helmets*

**KSB-011** Per prodotto cerchi  
*For product for rims*

KIT BARRE DI SICUREZZA  
SAFETY BARS KIT

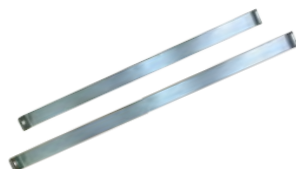

**CXAD** Per aspiratore AD singolo  
*For single vacuum-cleaner AD Model*

**CXADD** Per aspiratore AD doppio  
*For double vacuum-cleaner AD Model*

**CXU2011/ECO** Per aspiratore singolo U2011 e ECO  
*For single vacuum-cleaner U2011 and ECO Model*

**CXU2011/ECO-D** Per aspiratore doppio U2011 e ECO  
*For double vacuum-cleaner U2011 and ECO Model*

**CXU4P** Per aspiratore 4 programmi  
*For 4 programs vacuum-cleaner*

**CXLIS** Per lavainterni a schiuma  
*For foam interiors cleaners*

**CXLISE** Per lavainterni 4 programmi  
*For 4 programs interiors cleaners*

**CXD** Per distributori di panno  
*For towel dispensers*

**CXEP** Per colonnine prodotto  
*For upright product dispensers*

**CXDTV** Per detergente vetri  
*Crystal cleansing liquid dispenser*

**CXASM** Per asciugamacchina  
*For car dryer*

**CXG** Per gonfia gomme grande  
*For big tyre inflator*





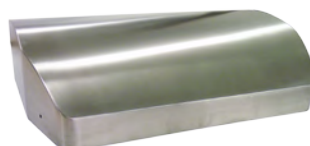





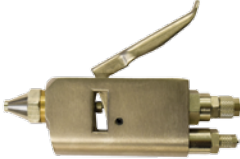











**CXGGC** Per gonfia gomme colonnina  
*For upright tyre inflator*

CAPPELLO INOX  
STAINLESS STEEL COVER

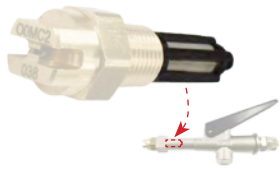

# RICAMBI

Spare parts















|   |   |  |   |
|---|---|--|---|
| <p><b>Pistola aria</b><br/><i>Air gun</i></p>  <p><b>ID0080</b></p>  | <p><b>Pistola battericida</b><br/><i>Bactericide gun</i></p>  <p><b>ID0077/A</b></p>                                       | <p><b>Pistola Inox per prodotto</b><br/><i>Inox gun for product</i></p>  <p><b>MC0221</b></p>  | <p><b>Pistola per prodotto</b><br/><i>Product gun</i></p>  <p><b>MC0114/C</b></p>                                |
| <p><b>Pistola detergi</b><br/><i>Gun for detergi</i></p>  <p><b>MC0268</b></p>   | <p><b>Pistola 4 profumi</b><br/><i>4 perfumes gun</i></p>  <p><b>4EG15/A</b></p>   | <p><b>Pistola 4 profumi con rubinetto</b><br/><i>4 perfumes gun with tap</i></p>  <p><b>4EG16</b></p>  | <p><b>Ugello per prodotto</b><br/><i>Nozzle for product</i></p>  <p><b>ID0117</b></p>                            |
| <p><b>Spazzola completa per lavinterni a schiuma</b><br/><i>Complete brush for foam interiors cleaner</i></p>  <p><b>LIS01</b></p>    | <p><b>Spazzola per lavinterni a schiuma</b><br/><i>Brush for foam interiors cleaner</i></p>  <p><b>LIS01/B</b></p>        | <p><b>Pistola con manico senza spazzola</b><br/><i>Tap for foam interiors cleaner</i></p>  <p><b>LIS01/C</b></p>                                  | <p><b>Pistola aria soffiante</b><br/><i>Air gun</i></p>  <p><b>MC0226/B</b></p>                                 |
| <p><b>Pistola inox prodotto cerchi e schiuma</b><br/><i>Inox gun for rims cleaner and foam machine</i></p>  <p><b>MC0222</b></p>     | <p><b>Pistola per prodotto cerchi</b><br/><i>Gun for rims cleaner</i></p>  <p><b>MC0113/C</b></p>                        | <p><b>Pistola per schiumogeno</b><br/><i>Gun for foam machine</i></p>  <p><b>MC0113/D</b></p>  | <p><b>Ugello per schiumogeno</b><br/><i>Nozzle for foam machine</i></p>  <p><b>ID0117/C</b></p>                |
| <p><b>Lancia lavinterni senza rubinetto</b><br/><i>Interiors cleaner nozzle without tap</i></p>  <p><b>MC0042/C</b></p>              | <p><b>Lancia lavinterni completa di rubinetto</b><br/><i>Interiors cleaner nozzle with tap</i></p>  <p><b>MC0042</b></p> | <p><b>Rubinetto completo per lancia lavinterni a estrazione</b><br/><i>Complete tap for Interiors cleaner nozzle</i></p>  <p><b>MC0042/B</b></p> | <p><b>Rubinetto lavinterni per lancia</b><br/><i>Interiors cleaner tap</i></p>  <p><b>ID0066</b></p>           |
| <p><b>Prolunga per rubinetto lancia lavinterni</b><br/><i>Extension's tap for Interiors cleaner nozzle</i></p>  <p><b>MC0041</b></p> | <p><b>Ugello lavinterni estrazione</b><br/><i>Nozzle for extraction interiors cleaner</i></p>  <p><b>MC0039</b></p>      | <p><b>Filtro per ugello lavinterni estrazione</b><br/><i>Filter for nozzle for extraction interiors cleaner</i></p>  <p><b>ID0066/A</b></p>      | <p><b>Attacco gonfiaggio senza molla</b><br/><i>Tyre connection without spring</i></p>  <p><b>ID0081/P</b></p> |



|   |  |  |   |
|---|--|--|---|
| <p><b>Attacco gonfiaggio con molla</b><br/><i>Tyre connection with spring</i></p>  <p><b>ID0081/N</b></p>  | <p><b>Molla per attacco gonfiaggio</b><br/><i>Spring for tyre connection</i></p>  <p><b>MC00076/H</b></p>                             | <p><b>Molla per tubo a spirale prodotto</b><br/><i>Spring for product spiral hose</i></p>  <p><b>MC00076/G</b></p>     | <p><b>Tubo e lancia americana per asciugamacchina</b><br/><i>American hose and lance for car dryer</i></p>  <p><b>MC0224</b></p>               |
| <p><b>Tubo aspirapolvere Ø 38/50 (5mt) completo di lancia</b><br/><i>Hose for vacuum-cleaner Ø38/50 (5mt) with lance</i></p>  <p><b>KMC161</b></p> | <p><b>Tubo aspirapolvere Ø 38/50 (5mt)</b><br/><i>Hose for vacuum-cleaner Ø 38/50 (5mt)</i></p>  <p><b>MC0284</b></p>                 | <p><b>Tubo lavainterni Ø 32 (al metro)</b><br/><i>Interiors cleaner hose Ø 32 (meter)</i></p>  <p><b>ID0104</b></p>    | <p><b>Tubo asciugamacchina Ø 50 (al metro)</b><br/><i>Hose for car and motorbike dryer Ø 50 (meter)</i></p>  <p><b>MC0165/B</b></p>            |
| <p><b>Tubo aspirapolvere Ø 38 (al metro)</b><br/><i>Vacuum cleaner hose Ø 38 (meter)</i></p>  <p><b>ID0118/B</b></p>                              | <p><b>Tubo per soffiatore</b><br/><i>Hose for blower</i></p>  <p><b>MC0165/F</b></p>   | <p><b>Tubo Superflex Calor Ø 50 (al metro)</b><br/><i>Superflex Calor hose Ø 50 (meter)</i></p>  <p><b>ID0119</b></p> | <p><b>Tubo pescante</b><br/><i>Hose</i></p>  <p><b>ID0067</b></p>   |
| <p><b>Tubo detergi</b><br/><i>Detergi hose</i></p>  <p><b>MC0192</b></p>   | <p><b>Tubo schiumogeno</b><br/><i>Foam machine hose</i></p>  <p><b>MC0225</b></p>   | <p><b>Tubo per lavainterni a schiuma</b><br/><i>Hose for foam interiors cleaner</i></p>  <p><b>MC0076/E</b></p>      | <p><b>Tubo per battericida</b><br/><i>Hose for antibacterial dispenser</i></p>  <p><b>MC0076/D</b></p>                                       |
| <p><b>Tubo a spirale con attacco gonfia gomme 1/8</b><br/><i>Spiral hose with tyre connection 1/8</i></p>  <p><b>MC0076/I</b></p>                | <p><b>Tubo a spirale 10 mt utili</b><br/><i>Spiral hose 10 mt</i></p>  <p><b>MC0076/B</b></p>                                       | <p><b>Tubo per 4 profumi</b><br/><i>Hose for 4 essences</i></p>  <p><b>MC0076/F</b></p>                              | <p><b>Raccordo tubo per aspirapolvere autopulente</b><br/><i>Hose connection for self-cleaning vacuum-cleaner</i></p>  <p><b>MCAS012</b></p> |
| <p><b>Raccordo tubo-lancia aspirapolvere</b><br/><i>Hose-lance connection for vacuum-cleaner</i></p>  <p><b>MCAS013</b></p>                      | <p><b>Raccordo tubo per aspirapolvere classico</b><br/><i>Hose connection for classic vacuum-cleaner</i></p>  <p><b>MCAS018</b></p> | <p><b>Raccordo tubo-lancia Ø 32</b><br/><i>Hose-lance connection Ø 32</i></p>  <p><b>MC0124</b></p>                   | <p><b>Raccordo tubo-lancia Ø 32 per LI</b><br/><i>Hose-lance connection Ø 32 for LI</i></p>  <p><b>MC0124/A</b></p>                          |











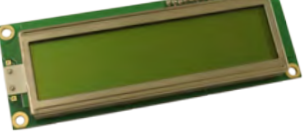

|   |   |   |   |  |   |
|---|---|---|---|--|---|
| <p><b>Manicotto Ø 32 per bidone per LI schiuma</b><br/><i>Coupling for drum for foam LI</i></p>  <p><b>MCLIS03</b></p>   | <p><b>Lancia aspirapolvere flessibile completa di raccordo</b><br/><i>Flexible vacuum-cleaner nozzle with connection</i></p>  <p><b>MC0285</b></p>   | <p><b>Lancia aspirapolvere</b><br/><i>Vacuum-cleaner nozzle</i></p>  <p><b>MCAS014</b></p>                        |   | <p><b>Lancia maxi Ø 58 mm</b><br/><i>Car dryer nozzle Ø 58 mm</i></p>  <p><b>ASM010</b></p> | <p><b>Impugnatura Ø 58 mm</b><br/><i>Handle Ø 58 mm</i></p>  <p><b>ASM009</b></p>              |
| <p><b>Letto card mini-smart compatto</b><br/><i>Compact mini-smart card reader</i></p> <p>Senza inibizione<br/><i>Without inhibition</i></p> <p><b>MNS-000</b></p> <p>Con inibizione<br/><i>With inhibition</i></p> <p><b>MNS-001</b></p>  | <p><b>Letto card mini-smart separato</b><br/><i>Separated mini-smart card reader</i></p> <p>Senza inibizione<br/><i>Without inhibition</i></p> <p><b>MNS-002</b></p> <p>Con inibizione<br/><i>With inhibition</i></p> <p><b>MNS-003</b></p>  | <p><b>Letto eurokey next</b><br/><i>Eurokey next reader</i></p>  <p><b>MC0142/NEW</b></p>                          | <p><b>Cavo</b><br/><i>Cable</i></p>  <p><b>MC0142/B</b></p>  | <p><b>Gettoniera meccanica</b><br/><i>Mechanic token-operated</i></p>  <p><b>MC0080</b></p> |   |
| <p><b>Frontale gettoniera elettronica F1</b><br/><i>Electronic token-operated F1 front</i></p>  <p><b>MC0059</b></p>  | <p><b>Gettoniera elettronica RM5</b><br/><i>Electronic token-operated RM5</i></p>  <p><b>MC0066</b></p>   | <p><b>Frontale gettoniera vending</b><br/><i>Front token-operated for vending</i></p>  <p><b>MC0262/A</b></p>    | <p><b>Gettoniera vending</b><br/><i>Vending token-operated</i></p>  <p><b>MC0261/A</b></p>        |  |   |
| <p><b>Copertura Inox per gettoniera</b><br/><i>Cover for token operated</i></p>  <p><b>Interna / Internal</b>      <b>Esterna / External</b></p> <p><b>CG01</b>      <b>CG02</b></p>   |   | <p><b>Cassetto Inox per gettoniera</b><br/><i>Box for token-coins for token-operated</i></p>  <p><b>PG01</b></p> | <p><b>Selettore a chiave completo</b><br/><i>Complete key selector</i></p>  <p><b>C.M.000</b></p> |  | <p><b>Scheda distributore carta</b><br/><i>Paper dispenser card</i></p>  <p><b>E0144</b></p> |
| <p><b>Scheda elettronica</b><br/><i>Electronic card</i></p>  <p><b>E0089/B</b></p>   | <p><b>Scheda vending</b><br/><i>Vending card</i></p>  <p><b>ESV9616010</b></p>   | <p><b>Schedina per gettoniera elettronica</b><br/><i>Card for token-operated</i></p>  <p><b>E0017/B</b></p>     | <p><b>Scheda foto diodi</b><br/><i>Card for diodes</i></p>  <p><b>E0086/B</b></p>                |  |   |
| <p><b>PLC LOGO 8</b><br/><i>PLC LOGO 8</i></p>  <p><b>E0154/A</b></p>  | <p><b>Espansione PLC LOGO 8</b><br/><i>PLC LOGO 8 expansion</i></p>  <p><b>E0155/B</b></p>   | <p><b>Scheda monoprogramma</b><br/><i>One-program card</i></p>  <p><b>E0124</b></p>                             | <p><b>Scheda doppio programma</b><br/><i>Two-program card</i></p>  <p><b>SCH.DOP.</b></p>        |  |   |

|   |  |   |   |
|---|--|---|---|
| <p><b>Fotodiodi blu/bianco</b><br/>Blue/white photo diodes</p>  <p>E0142/B - Blu E0142/C - Bianco</p>        | <p><b>Pulsante antivandalismo Ø 19 completo di micro interruttore</b><br/>Anti-vandalism button Ø 19 with micro switches</p>  <p>MC0072/C</p> | <p><b>Pulsante antivandalismo Ø 19</b><br/>Anti-vandalism button Ø 19</p>  <p>MC0072</p>                            | <p><b>Micro interruttore pulsante antivandalismo</b><br/>Micro switch for anti-vandalism button</p>  <p>MC0072/F</p> |
| <p><b>Pulsante di stop completo</b><br/>Complete stop button</p>  <p>PULS. STOP</p>                          | <p><b>Spie LED 24V bianca/rossa/verde</b><br/>White/red/green led 24 V lights</p>  <p>E0002/B E0002/E E0002/H</p>                             | <p><b>Motore 230 V per distributore pelle</b><br/>230 V motor for tear-off leather dispenser</p>  <p>DPCX018</p>    | <p><b>Motore Pannomatic 230V</b><br/>230 V Pannomatic motor</p>  <p>MTPM01</p>                                       |
| <p><b>Motore 24 V DC per distributore carta</b><br/>24 V DC motor for paper dispenser</p>  <p>DPCX018/B</p> | <p><b>Motore per lavatappeti 400 V</b><br/>Motor for car-mats washer 400 V</p>  <p>MC008/B</p>   | <p><b>Motore per lavatappeti 230 V</b><br/>Motor for car-mats washer 230 V</p>  <p>MC008/C</p>                     | <p><b>Motore per aspiratore monofase 230 V</b><br/>230 V Motor for monophase vacuum-cleaner</p>  <p>ASP-TEST</p>    |
| <p><b>Turbina aria motore 0,4 kW 400 V</b><br/>0,4 kW 400 V turbine motor air</p>  <p>TF023</p>            | <p><b>Turbina 1.5 kW monofase</b><br/>1.5 kW monophase turbine</p>  <p>TF006</p>  | <p><b>Turbina 2,2 kW 230-400 V per U2011/ECO 400</b><br/>2.2 kW 230-400 V U2011/ECO 400 turbine</p>  <p>TF010</p> | <p><b>Turbina 2.2 kW 230-400 V</b><br/>2.2 kW 230-400 V turbine</p>  <p>TF007</p>                                  |
| <p><b>Turbina 3 kW 230-400 V</b><br/>3 kW 230-400 V turbine</p>  <p>TF008</p>                              | <p><b>Turbina 11 kW 345-415 V</b><br/>11 kW 345-415 V turbine</p>  <p>CENTF01</p>   | <p><b>Filtro di fondo</b><br/>Bottom filter</p>  <p>ID0111</p>   | <p><b>Valvola Bypass</b><br/>Bypass Valves</p>  <p>ID0138/B</p>  |
| <p><b>Pompa detersivi 230 V</b><br/>230 V detersi pump</p>  <p>ID0176</p>                                  | <p><b>Pompa inox per prodotto 24 V DC</b><br/>24 V DC Inox pump for product</p>  <p>ID0064/B</p>  | <p><b>Pompa 230 V</b><br/>230 V pump</p>  <p>ID0064</p>   | <p><b>Pompa rossa viton 230 V</b><br/>230 V red pump in viton</p>  <p>ID0152/B</p>                                 |

|  |  |   |   |
|--|--|---|---|
| <p><b>Micro pompa per battericida</b><br/><i>Micro-scale pump for bactericide</i></p>  <p><b>ID0065/B</b></p>   | <p><b>Pompa dosatrice</b><br/><i>Metering pump</i></p>  <p>220 V      24 V</p> <p><b>ID0034/B</b>      <b>ID0034</b></p>  | <p><b>Dosatrice</b><br/><i>Micro-metering</i></p>  <p>24 V      230 V</p> <p><b>MC0222/B</b>      <b>MC0222/C</b></p>   | <p><b>Valvola iniezione per lavainterni</b><br/><i>Injection valve for interiors cleaner</i></p>  <p><b>ID0034/C</b></p>                         |
| <p><b>Compressore battericida per lavainterni LI-S</b><br/><i>Compressor for interiors cleaner LI-S</i></p>  <p><b>MC0204</b></p>   | <p><b>Compressore gonfiagomme 230 V</b><br/><i>230 V compressor</i></p>  <p><b>CGG</b></p>  | <p><b>Gruppo gonfiaggio omologato Ø 80</b><br/><i>Homologated inflator group Ø 80</i></p>  <p><b>GA/A</b></p>   | <p><b>Gruppo gonfiaggio omologato Ø 160</b><br/><i>Homologated inflator group Ø 160</i></p>  <p><b>GA/B</b></p>                                  |
| <p><b>Gruppo gonfiaggio omologato Ø 80</b><br/><i>Homologated inflator group Ø 80</i></p>  <p><b>GCA/A</b></p>   | <p><b>Gruppo gonfiaggio omologato Ø 160</b><br/><i>Homologated inflator group Ø 160</i></p>  <p><b>GCA/B</b></p>   | <p><b>Manometro Ø 80</b><br/><i>Pressure gauge Ø 80</i></p>  <p><b>ID0058/B</b></p>  | <p><b>Manometro Ø 160</b><br/><i>Pressure gauge Ø 160</i></p>  <p><b>ID0085/E</b></p>   |
| <p><b>Pistola gonfia gomme omologata</b><br/><i>Homologated gun for tyre inflator</i></p>  <p><b>ID0080/C</b></p>   | <p><b>Bit aria</b><br/><i>Bit air</i></p>  <p><b>ID0028/B</b></p> <p><b>Manometro per bit</b><br/><i>Bit manometer</i></p>  <p><b>ID0085</b></p> | <p><b>Bit acqua</b><br/><i>Bit water</i></p>  <p><b>ID0010/B</b></p> <p><b>Manometro per bit</b><br/><i>Bit manometer</i></p>  <p><b>ID0085</b></p>   | <p><b>Filtro acqua 1/2"</b><br/><i>1/2" Water Filter</i></p>  <p><b>MC0078</b></p>   |
| <p><b>Filtro autopulente</b><br/><i>Self-cleaning filter</i></p>  <p><b>MCAS005/A</b></p>   | <p><b>Bidone autopulente</b><br/><i>Drum for self-cleaning vacuum-cleaner</i></p>  <p><b>MCAS001</b></p>  | <p><b>Bidone per lavainterni con schiuma</b><br/><i>Drum for interiors cleaner with foam</i></p>  <p><b>MCLIS01</b></p>   | <p><b>Filtro classico</b><br/><i>Classic filter</i></p>  <p><b>MCAS016</b></p>   |
| <p><b>Bidone classico</b><br/><i>Classic drum</i></p>  <p><b>senza filtro</b><br/><i>without filter</i></p> <p><b>MCAS024/A</b></p>  <p><b>con filtro</b><br/><i>with filter</i></p> <p><b>MCAS024/B</b></p> | <p><b>Bidone classico completo</b><br/><i>Classic drum with filter and cover</i></p>  <p><b>MCAS024/C</b></p>   | <p><b>Bidone per ECO 400</b><br/><i>ECO 400 drum</i></p>  <p><b>senza filtro</b><br/><i>without filter</i></p> <p><b>MCAS024/E</b></p>  <p><b>con filtro</b><br/><i>with filter</i></p> <p><b>MCAS024/D</b></p> | <p><b>Guarnizione bidone per aspirapolvere autopulente</b><br/><i>Drum gasket for self-cleaning vacuum-cleaner</i></p>  <p><b>MC0093/E</b></p> |

|  |   |   |  |  |
|--|---|---|--|--|
| <p><b>Guarnizione bidone per aspirapolvere U2011</b><br/>Drum gasket for self-cleaning vacuum-cleaner U2011</p>  <p><b>MC0093/F</b></p> | <p><b>Coperchio bidone schiuma</b><br/>Cover for foam drum</p>  <p><b>MCLIS02</b></p>  | <p><b>Coperchio bidone aspirapolvere</b><br/>Drum cover for vacuum-cleaner</p>  <p><b>MCAS025</b></p>                   | <p><b>Flussostato</b><br/>Flow switch</p>  <p><b>ID0091/A</b></p>   |  |
| <p><b>Flussimetro</b><br/>Flow sensor</p>  <p><b>ID0210</b></p>   | <p><b>Elettro valvole lavatappeti 24 V AC + kit aria compressa</b><br/>Solenoid valve for 24 V AC car-mat + compressed air kit</p>  <p><b>E0147/C</b></p>  | <p><b>Elettro valvole 230 V AC colonnina aria</b><br/>230 V AC solenoid valve for air column</p>  <p><b>E0147/B</b></p> | <p><b>Pressostato per gonfia gomme</b><br/>Pressure switch for tyre inflators</p>  <p><b>ID0148/B</b></p>                 |  |
| <p><b>Pressostato per lavainterni a schiuma</b><br/>Pressure switch for foam interiors cleaner</p>  <p><b>ID0148/C</b></p>             | <p><b>Pressostato monofase con interruttore</b><br/>Monophase pressure switch with button</p>  <p><b>ID0148/D</b></p>   | <p><b>Gancio Inox per colonnina</b><br/>Hook for upright dispenser</p>  <p><b>CX013</b></p>                            | <p><b>Copertura per tubo a spirale gonfia gomme</b><br/>Cover spiral hose tyre inflator</p>  <p><b>K.GSAG</b></p>        |  |
| <p><b>Fotocellula 24V AC</b><br/>24 V AC photocell</p>  <p><b>E0086</b></p>   | <p><b>Sensore pedale lavatappeti</b><br/>Car-mat washer pedal sensor</p>  <p><b>E0136/C</b></p>  | <p><b>Termostato</b><br/>Thermostat</p>  <p><b>ID0053/B</b></p>   | <p><b>Reed per lavatappeti</b><br/>Reed for car-mat washers</p>  <p><b>E1000</b></p>                                    |  |
| <p><b>Serratura PF 15 chiave 9233</b><br/>Lock PF 15 with key 9233</p>  <p><b>MC0088</b></p>  | <p><b>Leve per serratura PF</b><br/>Lever for lock PF</p>  <p><b>Piana / Flat</b>      <b>9 mm / 9 mm</b>      <b>15,5 mm / 15,5 mm</b></p> <p><b>MC0087</b>      <b>MC0087/A</b>      <b>MC0087/B</b></p> |   | <p><b>Serratura a scomparsa</b><br/>Foldaway lock</p>  <p><b>MC0009</b></p>  | <p><b>Leva 20x3 per serratura</b><br/>20x3 lever for Lock</p>  <p><b>MC0010</b></p> |
| <p><b>Serratura chiusura a 3 punti 22x18</b><br/>Three points lock 22x18</p>  <p><b>MC0009/A</b></p>                                  | <p><b>Ruota Pannomatic</b><br/>Pannomatic wheel</p>  <p><b>MC0123</b></p>  | <p><b>Gruppo ruote completo Pannomatic</b><br/>Complete wheels group for Pannomatic</p>  <p><b>PAN-GR.01</b></p>      | <p><b>Cuscinetto distributore carta/Pannomatic</b><br/>Bearing paper dispenser and Pannomatic</p>  <p><b>MC0030</b></p> |  |

|   |   |   |   |  |  |
|---|---|---|---|--|--|
| <p><b>Coppia cuscinetti lavatappeti</b><br/><i>Bearing pair car-mat washer</i></p>  <p><b>MC0030/C</b></p>                                   | <p><b>Coppia perni spazzola lavatappeti</b><br/><i>Pin couple for car-mat brush</i></p>  <p><b>LTS003</b></p>                            | <p><b>Puleggia lavatappeti grande</b><br/><i>Big pulley for car-mat washers</i></p>  <p><b>MC0089</b></p>                 | <p><b>Puleggia lavatappeti piccola</b><br/><i>Small pulley for car-mat washers</i></p>  <p><b>MC0090</b></p>                   |  |  |
| <p><b>Spazzola lavatappeti</b><br/><i>Car-mat washer brush</i></p>  <p><b>LTS001</b></p>   | <p><b>Getto snodabile</b><br/><i>Articulated jet</i></p>  <p><b>MC0152/C</b></p>   | <p><b>Ugello lavatappeti</b><br/><i>Car-mat washer nozzle</i></p>  <p><b>MC0152/B</b></p>                                  | <p><b>Cinghia lavatappeti</b><br/><i>Car-mat washer belt</i></p>  <p><b>MC0100/B</b></p>  | <p><b>Piletta lavandino</b><br/><i>Sink</i></p>  <p><b>ID0055</b></p> | <p><b>Tubo uniflex per piletta</b><br/><i>Uniflex hose for sink</i></p>  <p><b>ID0055/B</b></p> |
| <p><b>Pedale meccanico per spremipelle e lavatappeti</b><br/><i>Squeezer and Car-mat washer mechanical pedal</i></p>  <p><b>ID0051</b></p> | <p><b>Pedale elettrico per spremipelle e lavatappeti</b><br/><i>Squeezer and Car-mat washer electric pedal</i></p>  <p><b>LTA12</b></p> | <p><b>Coppia rulli spremipelle</b><br/><i>Roller couple for leather squeezer</i></p>  <p><b>RULLSP</b></p>              | <p><b>Bronzine spremipelle</b><br/><i>Bushes for leather squeezer</i></p>  <p><b>SP0002</b></p>                               |  |  |
| <p><b>Maniglia spremipelle</b><br/><i>Leather squeezer handle</i></p>  <p><b>MC0148</b></p>  | <p><b>Alimentatore vending</b><br/><i>Vending power supply</i></p>  <p><b>E0017/D</b></p>  | <p><b>Display grande Vending 105mm x 35mm</b><br/><i>Big display for vending 105mm x 35mm</i></p>  <p><b>MC0264</b></p> | <p><b>Display piccolo Vending 71mm x 25mm</b><br/><i>Small display for vending 71mm x 25mm</i></p>  <p><b>ESV9616011</b></p> |  |  |
| <p><b>Fine corsa gettoniera meccanica</b><br/><i>End of stroke token-operated</i></p>  <p><b>MC0137</b></p>                                | <p><b>Fine corsa vending + Pannomatic-N</b><br/><i>End of stroke for vending + Pannomatic-N</i></p>  <p><b>ESV9616009</b></p>          | <p><b>Pulsante vending</b><br/><i>Vending button</i></p>  <p><b>MC0275</b></p>  | <p><b>Spazzola per distributore LI schiuma</b><br/><i>Brush for brush dispenser</i></p>  <p><b>MC0127/B</b></p>              |  |  |
| <p><b>Bobina Sontara 800 strappi per PM-N</b><br/><i>Sontara roll 800 tears for PM-N</i></p>  <p><b>PM001</b></p>                          | <p><b>Rotolo carta per mod. DC/DCXN</b><br/><i>Paper roll for DC/DCXN model</i></p>  <p><b>ROTOC</b></p>                               | <p><b>Rotolo panno carta per mod. DPC</b><br/><i>Paper towel roll for DPC model</i></p>  <p><b>ROTODPC</b></p>          | <p><b>Rotolo pelle per mod. DP</b><br/><i>Leather roll for DP model</i></p>  <p><b>ROTOP</b></p>                             |  |  |

Alla nostra Spett.le Clientela

L'A.D. Produzione ha il piacere di presentarVi il suo nuovo catalogo/listino 2022 che, a partire dal 1 Aprile 2022, annulla e sostituisce i precedenti. Nel ringraziarVi per la preferenza accordataci, cogliamo l'occasione per augurarVi un buon lavoro.

Condizioni di vendita:

- 1 ▶ **Modalità di pagamento:** anticipato a merce pronta.
- 2 ▶ **IVA 22%** a carico del Cliente.
- 3 ▶ **Trasporto:** escluso, a carico del Cliente.
- 4 ▶ **Montaggio:** escluso, a cura del Cliente.
- 5 ▶ **Pagamenti:** si accettano pagamenti solamente eseguiti presso il domicilio di A.D. Produzione S.r.l.
- 6 ▶ **Applicazione degli interessi:** ai ritardi di pagamento dei prodotti consegnati si applicheranno gli interessi di cui il Decreto Legislativo 231/2002 e la prima comunicazione di sollecito trasmessa da A.D. varrà quale messa in mora.
- 7 ▶ **Vendita con patto di riservato dominio:** fino alla data in cui A.D. non abbia ricevuto il pagamento dell'intero prezzo dei prodotti forniti, tali prodotti rimarranno di proprietà di A.D. Qualora quest'ultima eserciti il diritto di ritiro dei prodotti consegnati, l'acquirente dovrà metterli a disposizione affinché l'A.D. Produzione possa accedere alla sede dell'acquirente per provvedere a riprenderli in proprio possesso.
- 8 ▶ **Tempi di consegna:** presunti 15gg lavorativi da accettazione ordine, data da confermare in fase di accettazione cliente della ns. conferma ordine.
- 9 ▶ **Garanzia:** 12 mesi solo su parti di ricambio con difetti all'origine (le spese di trasporto sono sempre a carico del cliente sia per l'invio del nuovo ricambio, sia per il reso del ricambio difettoso). La garanzia decade se: A) i materiali sono stati manomessi/smontati/riparati da persone non autorizzate; B) i materiali sono stati danneggiati per incuria o colpa dell'acquirente; C) non si può provare la data certa di acquisto; D) il documento d'acquisto risulta contraffatto o non congruente con il tipo di prodotto o la data d'acquisto dello stesso.
- 10 ▶ Tutte le nostre macchine sono complete di manuale uso manutenzione e dichiarazione conformità CE.
- 11 ▶ A.D. Produzione non risponde di eventuali ritardi nelle consegne, non imputabili alla propria diretta responsabilità.
- 12 ▶ Il cliente è tenuto a controllare il materiale alla consegna in presenza dell'autista, in quanto A.D. non risponde di eventuali danni dopo la consegna. In caso di merce danneggiata è necessario firmare il ddt. con riserva di controllo specificandone la motivazione.
- 13 ▶ **Accettazione dei prodotti:** tutti i reclami per danni conseguenti al trasporto o per eventuali quantità mancanti rispetto ai prodotti ordinati per iscritto (mezzo lettera raccomandata) entro e non oltre 8 giorni lavorativi dalla data di consegna. Qualora entro detto termine non sia stato presentato alcun reclamo, i prodotti s'intenderanno accettati dall'acquirente.
- 14 ▶ **Legge applicabile e risoluzione delle controversie:** per quanto non previsto dalle presenti condizioni generali di vendita sarà applicabile il codice civile e qualsiasi controversia sarà devoluta alla competenza esclusiva del Tribunale di Milano.
- 15 ▶ A.D. Produzione si riserva il diritto di modificare senza preavviso prezzi, immagini e caratteristiche tecniche dei suoi prodotti, per miglioramenti tecnici e funzionali. Tutti i dati contenuti nel presente catalogo sono quindi da considerarsi indicativi e non vincolanti.

Dear Customer,

A.D. Produzione is pleased to present its new price list/catalogue in force and valid from 1st April 2022, that cancels and replaces the previous versions. Thanking you in preferring our company, our best wishes and good luck with your work.

Sales Conditions:

- 1 ▶ **Payment methods:** anticipated at availability of goods.
- 2 ▶ **IVA 22%** only for Italy.
- 3 ▶ **Shipping:** excluded, at Customer's expense.
- 4 ▶ **Assembly:** excluded, managed by Customer.
- 5 ▶ **Payments:** A.D. Produzione s.r.l. accepts payments only at our head office.
- 6 ▶ **Application of the interests:** will be applied for late payment of the products delivered as per Legislative Decree 231/2002 and the first reminder communication by A.D. Produzione will be worth formal notice.
- 7 ▶ **Agreement for retention of title:** until the date that A.D. Produzione has not received the full value of the supplied products, those products will remain property of A.D. Produzione. If the latter exercises the right of withdrawal of the products delivered, the buyer must make available to them that A.D. Produzione can access the buyer's venue to resume it in their possession.
- 8 ▶ **Delivery time:** approximately 15 work days from order acceptance; delivery date will be confirmed on order confirmation from Customer.
- 9 ▶ **Warranty:** 12 months only on replacement parts with factory default (shipping costs are always at customer's expense in all circumstances: delivery of the replacement and for the replacement of defective spare parts).  
The warranty is void if: the materials have been tampered with/disassembled repaired by unauthorized person; the materials were damaged due to negligence or fault of buyer; you cannot prove the certain date of purchase; the purchase document is counterfeit or inconsistent with the kind of product or with the date of purchase.
- 10 ▶ All of our machines are supplied with maintenance manual and CE declaration of conformity.
- 11 ▶ A.D. Produzione does not respond for delays in deliveries, which are not attributed to our direct responsibility.
- 12 ▶ The customer is required to verify goods in presence of the driver, as A.D. Produzione does not respond to any damage after delivery. In case of damaged goods it is necessary to sign the delivery note, with reserve of good to control and specifying the reason.
- 13 ▶ **Acceptance of products:** all claims for damage caused by transport or for missing quantities referred to the products with written order (registered letter) no later than 8 working days from the date of delivery. If no claim has been filed within that period, the products will be deemed accepted by the purchaser.
- 14 ▶ **Law terms and Disputes settlement:** Notwithstanding these general conditions of sale, the Civil Code shall apply and any dispute shall be transferred to the exclusive jurisdiction of the Court of Milan.
- 15 ▶ A.D. Produzione, for technical and functional improvements, reserves the right to modify without notice prices, images and technical features of its products. All data contained in this catalogue should therefore be considered as indicative and non-binding.

Tutti i prodotti della  
A.D. Produzione S.r.l.  
sono coperti da certificazione

*All the products of  
A.D. Produzione S.r.l.  
are covered by certification*

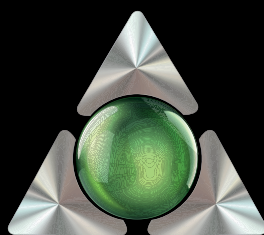

**A.D. Produzione s.r.l.**



Via Darwin, 18 - 20019 Settimo Milanese (MI) - Italia

Tel. +39 02 33 50 24 97 - Fax +39 02 33 50 39 84

**info@adproduzione.it - www.adproduzione.com**

